

Operator's Manual

CDI OneView™ Monitoring System



Table of Contents

System Overview

Indications for Use.....	1-1
How the System Works	1-4
System Components	1-8
Battery Power.....	1-25

Initial Assembly and Admin Setup

System Hardware Assembly	2-1
Administrator Setup	2-12
System Settings	2-14

Case Profile Configuration

The Toolbar	3-1
Case Profile Management	3-4

Calibration and Circuit Setup

Calibration	4-1
Sensors and Cuvettes	4-10

Running a Case

Initiate Measurement Mode	5-1
Measurement Mode Taskbar	5-4
In Vivo Recalibration	5-10
Concluding a Case	5-14
Data Export.....	5-16

Table of Contents

Troubleshooting

Error Messages and Conditions.....	6-1
Laboratory Comparison Troubleshooting Table.....	6-16

Routine Maintenance and Disposal

Routine Cleaning	7-1
Battery Maintenance.....	7-2
Replacement Procedures.....	7-3
System Disposal.....	7-3

System Components

Brackets.....	A-1
Flow Components.....	A-1
Disposables	A-1
External Data Modules	A-2
Accessories	A-2

System Specifications

Manufacturer-Defined Default Alarm Limits.....	B-1
System Operating Ranges	B-2
System Display Ranges	B-3
System Accuracy	B-4
Environmental Specifications.....	B-6
Electrical Specifications.....	B-7
Physical Specifications.....	B-16

Table of Contents

Unpacking and Inspection	B-17
Calculations	B-18

Communication with Other Devices

Connecting an External Device to the Port	C-2
Data Output Port Pin Assignments.....	C-3
CDI Pump Interface Protocol.....	C-7

Symbols Glossary

Symbols Glossary	D-1
Standards.....	D-8

Warranty and Service

Warranties	E-1
Limitations of Remedies.....	E-1
Service.....	E-2
Returned Goods Policy	E-2

Software License

End User License Agreement: CDI OneView System Software.....	F-1
---	-----

Glossary and Acronyms

Glossary.....	G-1
---------------	-----

System Overview

The Terumo Cardiovascular CDI OneView™ System (CDI OneView) is a blood monitoring system to be used on a single patient during cardiopulmonary bypass procedures. The CDI OneView System continuously monitors the blood in the extracorporeal circuit and provides ongoing information about the blood parameters, which is displayed on its easy-to-read screen.

The CDI OneView System is a modular and user-configurable design comprised of a central Core, a Display, a Calibrator unit, probes for different parameters measurements, cables to external module devices, mounting accessories and disposables.

The CDI OneView System can display potential of Hydrogen (pH), partial pressure of Oxygen (pO₂) and partial pressure of Carbon Dioxide (pCO₂) parameters either at actual temperature or adjusted to 37°C.

The CDI OneView System and all related accessories are latex-free.

Indications for Use

The CDI OneView Monitoring System is a patient parameter monitoring system to be used on a single patient during cardiopulmonary bypass procedures. By measurement or acquisition from other devices, it displays and outputs information to provide continuous, in-line monitoring of various patient parameters contained within the extracorporeal perfusion circuit and patient. The following parameters are available, based on configuration:

- Potential of Hydrogen (pH)
- Partial Pressure of Carbon Dioxide (pCO₂)
- Partial Pressure of Oxygen (pO₂)
- Potassium Ion (K⁺)
- Oxygen Saturation (SO₂)
- Hematocrit (HCT)
- Hemoglobin (Hgb)
- Blood Flow Rate (Q̇)
- Cardiac Index (CI)
- Base Excess (BE)
- Bicarbonate (HCO₃⁻)
- Oxygen Consumption (VO₂)
- Indexed Oxygen Consumption (VO₂i)
- Oxygen Delivery (DO₂)
- Indexed Oxygen Delivery (DO₂i)
- Cerebral Regional Oxygen Saturation (rSO₂)
- Oxygen Extraction Ratio (O₂ER)
- Body Surface Area (BSA)
- Shunt Sensor Temperature

Contraindications

None.

System Overview

Intended Patient Population

The CDI OneView System is used during cardiopulmonary bypass procedures with patient populations ranging from neonates to adults.

Frequently Used Functions

- Module components connection
- Connecting probes and components
- Setting probes configuration
- Setting display configuration
- Exporting case data
- Monitoring parameters
- Performing in-vivo recalibration
- Adjusting patient blood parameters values
- Marking key clinical events during monitoring
- Changing O₂ consumption
- Switching temperature measurement method between alpha-stat and pH-stat
- Adjusting arterial blood temperature to the desired range
- Adjusting system display angle
- Monitoring alarm signals
- Adjusting alarm volume
- Alarm limits setting
- Alarm inactivation

User Profile

This system is operated by a perfusionist in possession of all licenses, certifications and/or training as required by the region(s) in which they practice, and it should never be left unattended.

Minimum Physical Requirements: The user must have the physical ability to stand for long periods of time and to stoop, bend, reach, grasp and sense as needed. They must be capable of lifting approximately 22 pounds (10 kilograms) from the floor location to countertop height and must possess normal visual and audible acuity (with correction if needed).

Clinical Benefits

Continuous in-line monitoring of blood gas parameters enables continuous patient monitoring to support perfusionist decisions during the cardiopulmonary bypass procedure and may indirectly improve patient outcomes.

Potential Undesirable Side Effects

- Delay to procedure
- Infection
- Embolism
- Unable to meet performance claims
- Adverse bodily reaction
- Hemolysis
- Blood loss

System Overview

Training Requirements

Before setup or operation of the CDI OneView System, it is vital that the user read and understand all the material in this manual. To arrange training, please contact your local Terumo Cardiovascular representative or call (800) 521-2818 and ask about CDI OneView System training.

For clarification or additional information, please direct questions to your local Terumo Cardiovascular representative, or you can contact:

Terumo Cardiovascular Systems Corporation
6200 Jackson Road, Ann Arbor, MI 48103
United States of America

Phone: (800) 521-2818

Conventions

This manual contains important sections pertaining to Warnings, Cautions, Notes and Admin Only functions:



Warning

- ✦ **Warnings like this alert you to safety issues with the CDI OneView System. You must read these warnings before using the CDI OneView System.**



Caution

- *Cautions contain important information about the operation and maintenance of the CDI OneView System. Read these carefully in order to avoid any problems.*

Note: Notes provide additional information on using the CDI OneView System.



ADMIN ONLY

Admin Only sections provide instructions on settings and functions only available to user accounts with administrative privileges (see [Chapter 2, "Administrator Setup"](#)).



ADMIN ONLY

System Overview

How the System Works

The CDI OneView System is an AC-powered, microprocessor-based system. The system uses an optical fluorescence technology to measure blood gases, pH and potassium. It additionally uses an optical reflectance technology to measure oxygen saturation, hematocrit and hemoglobin.

Optical fluorescence measurements are taken through a Blood Parameter Module (BPM) connected to a disposable Shunt Sensor. Optical reflectance measurements are taken through the Hematocrit/Saturation (H/S) Probe connected to a disposable cuvette. Shunt Sensors and cuvettes are incorporated in the extracorporeal circuit. Flow measurements are taken through a Flow Sensor attached to tubing on the extracorporeal circuit.

Critical Operating Parameters and Warnings Prior to Operation of the CDI OneView Monitoring System

Any user of the CDI OneView System must read and understand all the information in this manual — the CDI OneView System Operator's Manual — as well as the instructions for use included with all associated disposables before using the system. Special attention must be paid to the following crucial safety information:



Warning

- ✦ **The Shunt Sensor accessory contains Germall II in the calibration fluid. A potential byproduct of Germall II may be formaldehyde. Exposure may cause adverse reactions in patients with formaldehyde sensitivity.**
- ✦ **The Shunt Sensor is heparin treated and should not be used with heparin sensitive patients. Devices with heparin treated surfaces may cause an adverse reaction.**
- ✦ **Use of the following substances can potentially cause inaccuracies in displayed values: Indocyanine green (Cardio-Green), Methylene Blue, or other intravascular dyes, carboxyhemoglobin or situations such as dyshemoglobins, hemoglobinopathies, elevated bilirubinemia and/or icterus (jaundice).**
- ✦ **Verify the accuracy of displayed values with another source (i.e., laboratory, point-of-care blood gas analyzer or independent flow measurement) before initiating treatment.**
- ✦ **Possible explosion hazard. Do not use the CDI OneView System in the presence of flammable anesthetics or other explosive gases.**
- ✦ **Do not use an apparently malfunctioning device in a procedure.**

System Overview



Warning

- ✦ **Computer equipment in the operating room environment may interfere with the operation of existing monitoring or therapeutic devices and may be susceptible to interference from such devices. To ensure that such interference will not occur, care must be taken in the selection of computer equipment to be interfaced with the CDI OneView System and the manner in which this interface is accomplished.**
- ✦ **Maintain adequate levels of anticoagulation during extracorporeal circulation by monitoring activated clotting time (ACT) or another appropriate measurement. Use of a heparin treated device does not substitute for adequate anticoagulation levels.**
- ✦ **Do not modify this equipment without written authorization of the manufacturer.**
- ✦ **Devices connected to an External Data Module must be compliant to IEC 60950-1 and/or IEC 62368-1, including any applicable National Deviations.**
- ✦ **Do not immerse the CDI Blood Parameter Module (BPM) or CDI H/S Probe in liquid at any time. Immersion can cause damage to electronic components within the fiberoptic head.**
- ✦ **Avoid prolonged exposure to high humidity environments.**
- ✦ **When Methylene Blue or similar dyes have been used prior to or during cardiopulmonary bypass, independent external blood gas and blood chemistry analysis is required for accurate determination of all measured parameters needed to guide therapeutic decisions. Readings obtained from the CDI OneView System for the following parameters should not be relied on to make therapeutic decisions when Methylene Blue has been used: pH, Potassium (K⁺), Base Excess (BE), Bicarbonate (HCO₃), Oxygen Delivery (DO₂), Oxygen Saturation (SO₂), and Oxygen Consumption (VO₂).**
- ✦ **Blood conditions such as hemoglobinopathies, thalassemia, and a variety of anemic conditions (sickle cell, iron deficiency, macrocytic), may affect the accuracy of Hgb and HCT measurements. Independent external analysis is required for accurate determination of these measurements as needed to guide therapeutic decisions.**
- ✦ **The CDI OneView System should only be used when there is blood flow through the extracorporeal circuit. To perform accurately, reference the minimum and maximum blood flow rates (Q) as listed in the H/S Cuvette Instructions for Use.**
- ✦ **The CDI Shunt Sensor requires a minimum of 35 mL/min of blood flow. Restoration of blood flow above the minimum through the CDI Shunt Sensor or the CDI H/S Cuvette will restore performance of the system.**
- ✦ **Do not make simultaneous contact with the patient and certain parts of non-medical electrical equipment.**

System Overview



- ✦ **Independent external blood gas and blood chemistry analysis is required for accurate determination of all measured parameters needed to guide therapeutic decisions whenever intravascular dyes are administered or when dyshemoglobins or elevated bilirubin levels are present.**
- ✦ **Use caution when administering novel pharmacological agents when the user is unfamiliar with the potential effect of such agents on the CDI sensors.**
- ✦ **Do not attempt in vivo recalibration expecting to re-align values affected by interference due to intravascular dyes or pharmacological agents; the interference may be prolonged resulting in continuing inaccuracies.**
- ✦ **Exposure of the Shunt Sensor to prime solutions and/or blood with pH less than 7.0 or greater than 7.8 pH units can interfere in the accurate measurement of potassium.**
- ✦ **Exposure of the Shunt Sensor to prime solutions and/or blood with sodium measurement less than 120 or greater than 160 mEq/L can interfere in the accurate measurement of potassium.**
- ✦ **Failure to perform a proper setup including a full two-point tonometered gas calibration and a complete calibration of the potassium sensor, including in vivo recalibration, may inhibit the system from achieving accuracy limits found in [Appendix B](#).**
- ✦ **Measured values prior to initial in vivo recalibration may not be accurate. Do not use values prior to initial in vivo recalibration for patient management. At the beginning of a case after the initiation of cardiopulmonary bypass and when conditions are stable, the user must complete recalibration of all measurable blood parameters by comparing them to a laboratory measurement done on a blood sample. The values are greyed out and not bold on the CDI OneView System screen to indicate the values are not accurate until an initial in vivo recalibration has been performed. After an in vivo recalibration is performed, the values become bold.**
- ✦ **After changes of blood temperature of $> 6^{\circ}\text{C}$, the user must repeat an in vivo recalibration of Shunt Sensor values once temperature stability has been achieved. Optimal system accuracy will be maintained by this practice.**
- ✦ **The temperature measured by the Shunt Sensor is local to the sensor and does not reflect the actual patient arterial or venous blood temperature. Do not use this measurement for patient management.**
- ✦ **To avoid risk of electrical shock and to achieve grounding reliability, the Core must only be connected to a supply mains with protective earth ground.**

System Overview



Caution

- *Federal (U.S.A.) law restricts this device to sale, distribution and use by or on the order of a physician.*
- *Do not connect a Shunt Sensor to an unprimed circuit. Prolonged “dry” exposure can damage the sensors.*
- *Do not use chemical solvents such as alcohol, ether, and acetone — or anesthetics such as Forane (isoflurane) — as cleaning agents on any part of the system. These chemicals can be destructive to the device. Follow the cleaning procedure in [Chapter 7, “Routine Cleaning,”](#) using only the recommended cleaning agents.*
- *Failure to follow the instructions can cause the monitoring system to display inaccurate values.*

The accuracy of the results is dependent upon the following:

- *Reading and understanding the instructions for use.*
- *Proper set-up, full two point tonometered gas calibration, and complete calibration of the potassium sensor and all other parameters.*
- *Use of all available system features.*
- *Periodic comparison to a laboratory reference sample for blood gas parameters.*

Note: The hemoglobin measurement technique used in this instrument measures total hemoglobin, and therefore includes other hemoglobin species such as carboxy-, met-, sulf-, and fetal hemoglobin. Terumo Cardiovascular CDI blood parameter monitoring systems are intended to monitor values including pH, pO_{2i}, pCO_{2i}, K⁺, SO_{2i}, HCT and Hgb. When used in accordance with their instructions for use, the systems have been demonstrated to provide reliable reports of these values with an accuracy characterized in [Appendix B](#).

System Overview

System Components

1

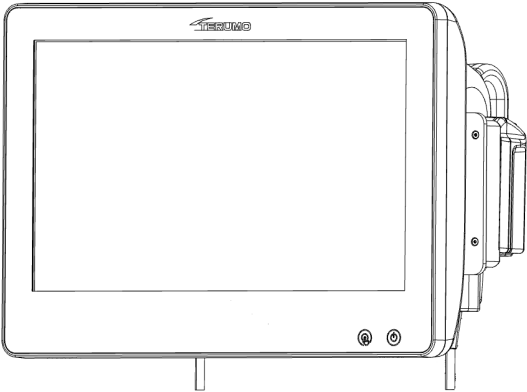

2

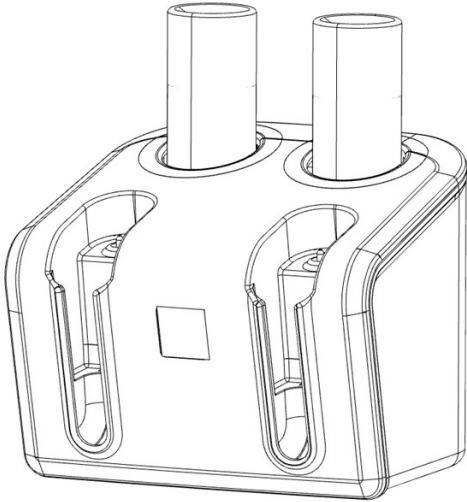

3

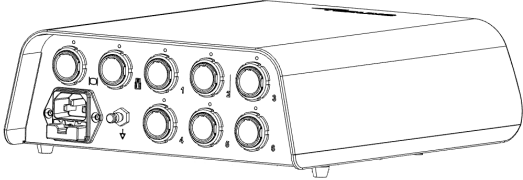



- 1. **CDI OneView Touchscreen Display** CDI751
- 2. **CDI OneView Calibrator** CDI740
- 3. **CDI OneView Processing Core** CDI750

System Overview

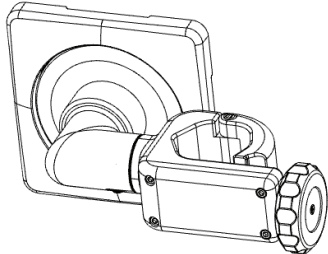
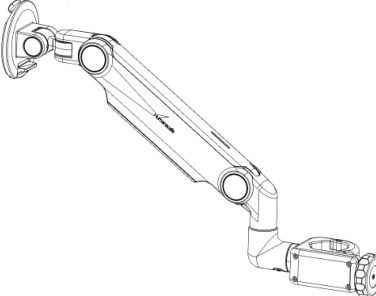
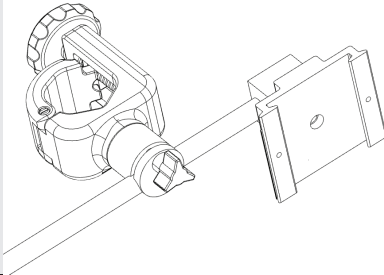
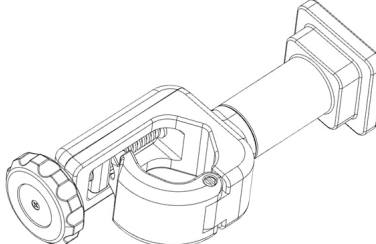
Brackets

Core Bracket	CDI780	
Display Bracket	CDI781	
BPM Bracket	CDI782	
Calibrator Bracket	CDI783	

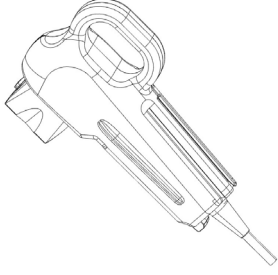
System Overview

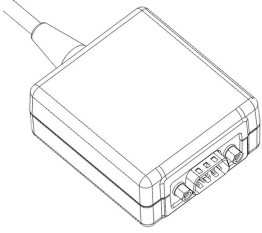
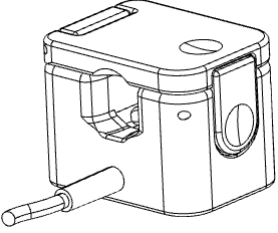
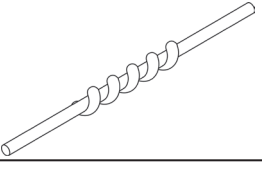
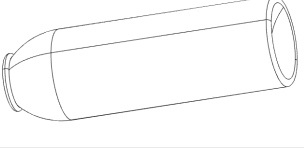
Additional Components		
CDI OneView BPM Probe	CDI753	
CDI OneView H/S Probe	CDI754	
CDI OneView Flow Interface Module	CDI760	
CDI OneView HLM Interface Module	CDI770	
CDI OneView DMS Interface Module	CDI771	
CDI OneView RSO ₂ Interface Module	CDI772	
CDI OneView Flow Sensor	CDI 763 CDI 764 CDI 768	
Sensor Identifier Kit	90002635	
CDI OneView Calibration Gas 1	CDI746	
CDI OneView Calibration Gas 2	CDI747	
CDI OneView Calibrator Cable <i>length 2.0 meters</i>		CDI741
CDI OneView Display Power Cable <i>length 2.1 meters</i>		CDI752

System Overview

Display

The Display is a configurable touchscreen that facilitates operation of the system, docks the BPM and H/S Probe(s), and provides a USB port to connect a USB drive.

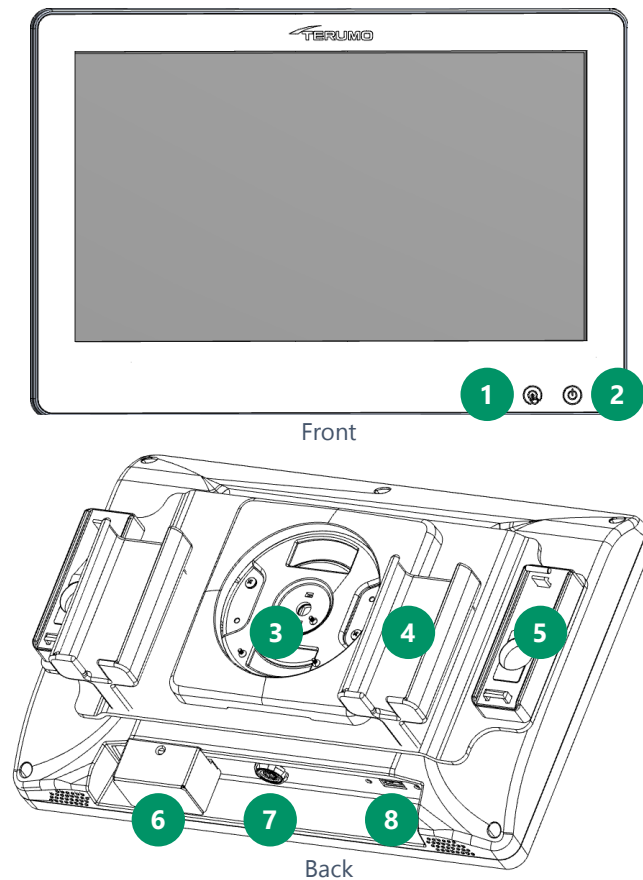

- 1. Touchscreen deactivation button:** To disable the touchscreen for cleaning, press and hold the button for one second. To reactivate the touchscreen, press and hold the button for one second.
- 2. System power button:** To switch the system on, press and hold the power button for one second. To turn the system off, press and hold the power button for two seconds. The light-emitting diode (LED) is steady white when the system is off and power is connected, flashes green while starting up, is steady green when ready for use, and flashes white while shutting down.
- 3. Display mount:** Connects the Display to the bracket.
- 4. BPM holder x 2:** Secures and protects the BPM(s) when not in use.
- 5. H/S Probe holder x 2:** Secures and protects the H/S Probe(s) when not in use. Incorporates a color chip for optical reference.
- 6. Barcode camera**
- 7. Display Cable port:** Connects the Display to the Core.
- 8. USB type A port:** for data storage.



Caution

- Do not use hard objects to operate the touchscreen.
- The USB port should not be used to charge external devices.

System Overview

Core

The CDI Core provides power to all connected modules and module-to-module communication, such as between the Calibrator and the BPM. Any calculated parameter that requires input from more than one module is calculated in the Core and sent to the Display. The Core has a 25-minute battery backup for use during transport or for emergency power.

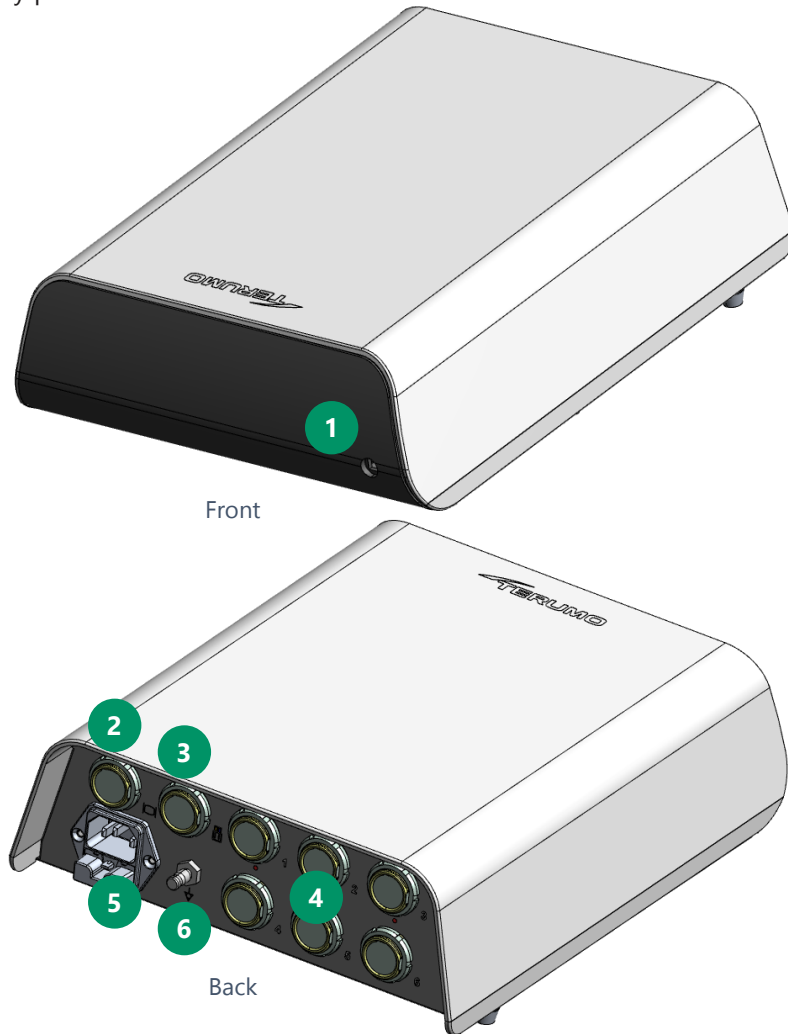

- 1. LED status indicator light:** Indicates functional status. The LED is steady white when the system is off and power is connected. The LED flashes green while the system is starting up. The LED is steady green when the system is ready for use. The LED flashes white while the system is shutting down.
- 2. Display port:** Interfaces with the CDI Model CDI751 OneView Touchscreen Display
- 3. Calibrator port:** Interfaces with the CDI Model CDI740 Calibrator.
- 4. Module ports x 6:** Attaches BPM(s), H/S(s), Flow Interface Module(s) and External Device Module(s).
- 5. Power connector:** Connects the power cable.
- 6. Ground equalization stud:** Used to reduce differences of electrical potential between bodies of medical electrical devices and conductive parts of other objects.

System Overview

BPM Probe

Arterial and/or venous blood parameter modules (BPM) are for monitoring pH, pO₂, pCO₂, K⁺ and temperature.

The BPM Probe receives power and commands from and transmits data and parameter values to the Core using a USB cable. The BPM cable is detachable from the Core, and the BPM probe may be replaced during a case in the event of a failure. The probe can be mounted on the CDI782 BPM Bracket, which can be attached securely to standard heart-lung machine (HLM) poles.

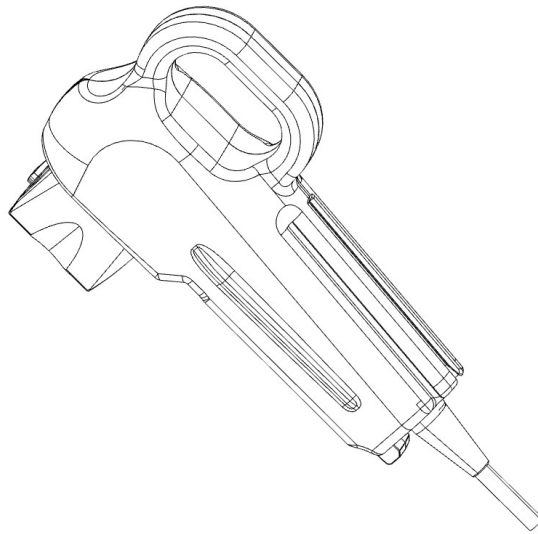

Caution

- Do not stare directly into the BPM optics LED.

H/S Probe

The H/S Probe is a module for measuring continuous oxygen saturation, hematocrit and hemoglobin.

The H/S Probe receives power and communicates with the Core via a cable. During use, the H/S Probe is attached to an H/S Cuvette within the extracorporeal circuit via a keyed mechanical interface.

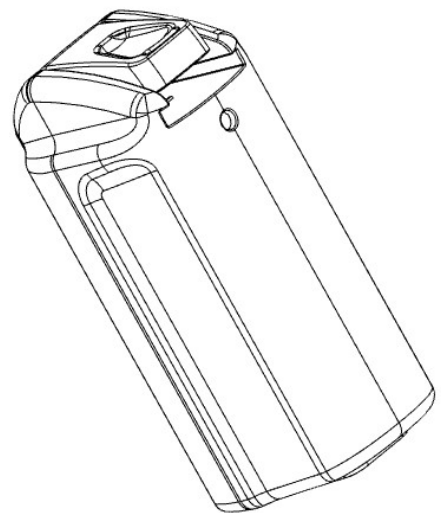

System Overview

Calibrator

The CDI Model 740 Calibrator uses gases for automatic calibration of the CDI OneView System and CDI Shunt Sensors. It can calibrate up to two sensors simultaneously.

Note: When calibrating only one CDI Shunt Sensor, either Calibrator pocket can be used. Gas flow will be automatically shut off to the unused Calibrator pocket.

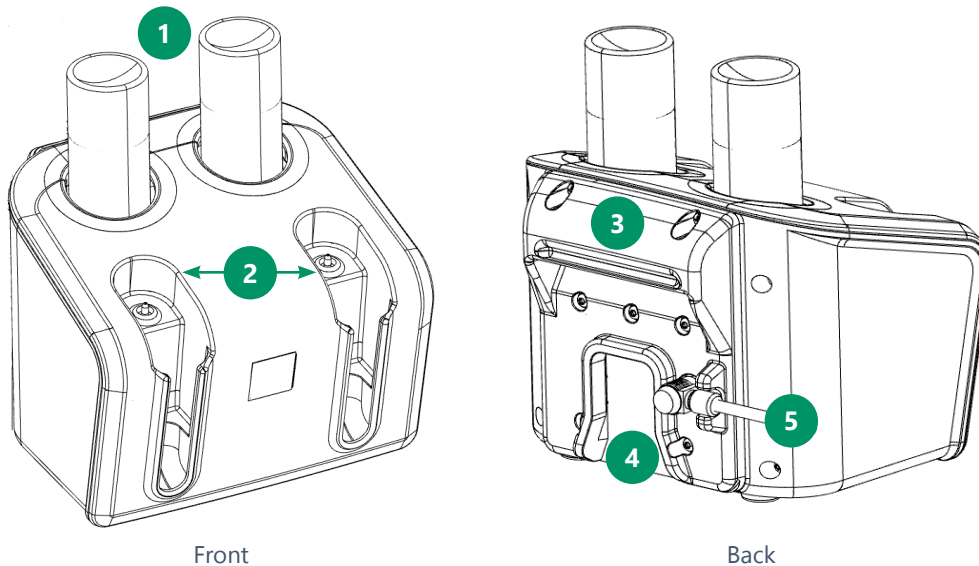

Front and Back of the Calibrator

1. **Gas bottle receptacles:** Holds the Gas 1 and Gas 2 bottles during calibration.
2. **Pockets:** Supports and aligns the sensor/BPM assembly during calibration.
3. **Handle:** Provides a grip when carrying the Calibrator by hand.
4. **Mount:** Facilitates attaching the Calibrator to the Calibrator Bracket.
5. **Cable:** Connects the Calibrator to the Core. Once connected, the Calibrator is powered by the Core.



Caution

- Always carry the Calibrator by the handle to minimize the risk of dropping it.

System Overview

Calibration Gases

The two-point tonometered calibration of the CDI Shunt Sensors requires the use of precision mixtures of carbon dioxide (CO₂) and O₂ gas to expose the sensors to well defined pH, pO₂ and pCO₂ values. A set of gas bottles provides enough gas for approximately 30 individual sensor calibration procedures.

Gas 1 (CDI Model CDI746):	Gas 2 (CDI Model CDI747):
CO ₂ : 7.5 +/- 0.1%	CO ₂ : 2.8 +/- 0.1%
O ₂ : 24 +/- 0.2%	O ₂ : 4.0 +/- 0.2%
N ₂ : Balance	N ₂ : Balance



Warning

- ✦ CONTAINS GAS UNDER PRESSURE; MAY EXPLODE IF HEATED.
- ✦ PROTECT FROM SUNLIGHT. STORE IN A WELL-VENTILATED PLACE



Caution

- Check the expiration date on the gas bottles before use. Use of the calibration gas bottles after expiration may result in inaccurate calibration.

CDI Shunt Sensor

The CDI Shunt Sensors contain the K⁺, pO₂, pCO₂ and pH fluorescent microsensors, as well as the thermistor contact site for temperature measurement. The sensors are single use, nontoxic and non-pyrogenic.

The heparin-coated, sterile CDI Shunt Sensors, Model CDI510H, are intended for placement into shunt lines, purge lines, sampling lines, shunt bypass lines or any similar line that has blood flow. A minimum flow requirement of 35 mL/min is necessary for proper measurement.

The disk-like filter/sparger on the sensor ensures a sterile barrier when the sensor is placed into the Calibrator. The sparger on the filter is located inside the sensor.

Do not remove this filter/sparger until placing the sensor into the circuit.

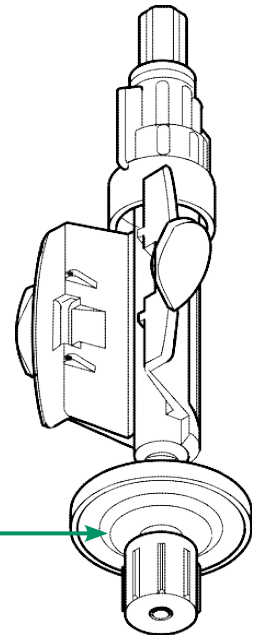

System Overview

CDI Model CDI510H Optical Interface

A transparent optical interface material found on the back side of the CDI Model CDI510H Shunt Sensors provides a consistent optical connection between the sensor and the fiberoptic cable connector. This material reduces the risk of measurement errors caused by moisture trapped between the microsensors and the BPM. A thermal well on each sensor facilitates the thermal transfer from the circuit to the thermistor cap located on each BPM.

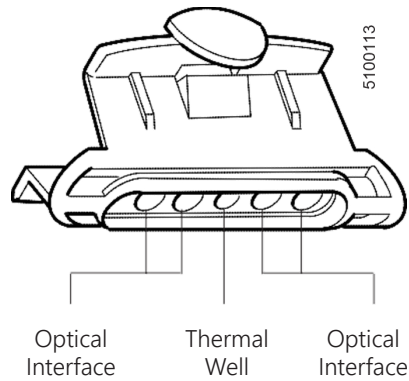

Each sensor contains a buffered calibration solution. This solution stabilizes the microsensors during storage. It also reacts with the tonometered gases during calibration to establish predictable pH, pO₂ and pCO₂ values.

Each CDI Shunt Sensor is intended for a single use. Aseptic technique must be used when adding the CDI Shunt Sensor to the circuit. Luer caps and a sterile filter/sparger assembly are provided on the sterile assemblies at each end of the Shunt Sensor to protect the blood pathway from contamination prior to insertion into the circuit.

The CDI Shunt Sensor remains sterile so long as the package is unopened and undamaged. Each Shunt Sensor is individually packaged in a foil pouch and has a recommended shelf life indicated by the lot number expiration date printed on each package. For additional information, refer to the Shunt Sensor instructions for use.



Warning

- ✦ **Products treated with heparin should not be used on patients with heparin sensitivity.**
- ✦ **Maintain adequate levels of anticoagulation during extracorporeal circulation by monitoring activated clotting time (ACT) or another appropriate measurement. Use of a heparin treated device does not substitute for adequate anticoagulation levels.**
- ✦ **Store CDI Shunt Sensors between 0°C (32°F) and 35°C (94°F). Freezing of the CDI Shunt Sensor, or storage at temperatures outside the stated range, can result in inaccurate performance.**
- ✦ **Do not reuse CDI Shunt Sensors. Used CDI Shunt Sensors are contaminated and cannot be resterilized. Resterilization damages the microsensors.**
- ✦ **Shunt Sensors are sterile, heparin-coated, non-toxic, non-pyrogenic, single use devices and for use in cardiopulmonary bypass procedures for up to 6 hours.**
- ✦ **Use of certain intravascular dyes during cardiovascular surgery such as: Indocyanine green (Cardio-Green) and Methylene Blue may cause inaccuracies in displayed values. Independent external blood gas and blood chemistry analysis is required for accurate determination of all measured parameters needed to guide therapeutic decisions.**

System Overview



Warning

- ✦ **Elevated levels of blood substances including irregular cell morphologies, protein levels, plasma free hemoglobin and bilirubin may interfere with blood measurements. Independent external blood gas and blood chemistry analysis is required for accurate determination of all measured parameters needed to guide therapeutic decisions.**
- ✦ **Independent external blood gas and blood chemistry analysis is required for accurate determination of all measured parameters needed to guide therapeutic decisions whenever intravascular dyes are administered or when dyshemoglobins or elevated bilirubin levels are present.**
- ✦ **Use caution when administering novel pharmacological agents when the user is unfamiliar with the potential effect of such agents on the CDI sensors.**
- ✦ **Do not attempt in vivo recalibration expecting to re-align values affected by interference due to intravascular dyes or pharmacological agents; the interference may be prolonged resulting in continuing inaccuracies.**



Caution

- *Do not use a CDI Shunt Sensor after the lot number expiration date printed on the package label. Using a CDI Shunt Sensor after its lot number expiration date can result in inaccurate performance.*
- *Do not use a CDI Shunt Sensor if the foil pouch it is packaged in has been damaged. A damaged foil pouch can result in inaccurate performance.*
- *This product contains Germall II in the calibration fluid. A potential byproduct of Germall II may be formaldehyde. Exposure may cause adverse reactions in patients with formaldehyde sensitivity.*

System Overview

The Shunt Bypass Line

The shunt bypass line is a tubing pack modification designed to connect to the CDI Shunt Sensor when an in-line application is desired. Two opposing Y-connectors allow a small fraction of the total blood flow to pass through the sensor while minimizing any additional flow resistance. The shunt bypass line is recommended when continuous venous side monitoring is desired and/or when a continuous shunt/purge line is not available on the arterial side. The lines can be supplied as sterile individual assemblies for incorporation into the circuit at the time of use, or by a tubing pack supplier as a modification to an existing tube pack. The three tubing sizes supported are 1/2", 3/8" and 1/4".

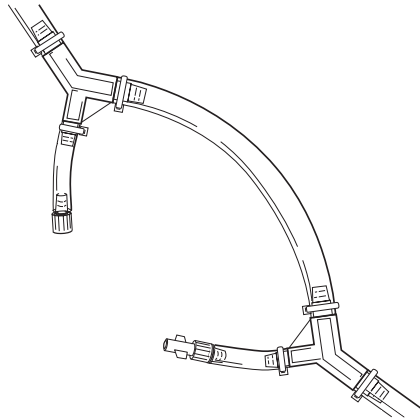

Warning

- ✦ **A minimum blood flow of 35 mL/min is recommended to maintain measurement performance of the Shunt Sensor. To maintain the minimum blood flow through the sensor, keep total blood flow in the shunt bypass line above 1.5 L/min for 1/2 inch tubing, 0.6 L/min for 3/8 inch tubing, and 0.2 L/min for 1/4 inch tubing.**
- ✦ **Use aseptic technique when inserting the shunt bypass line into the extracorporeal circuit to ensure that the blood contact surfaces remain sterile.**
- ✦ **For all shunt bypass line applications: Use an arterial filter distal to the shunt bypass line when utilizing the shunt bypass line on the arterial side of the circuit. This protects against the introduction of air into the blood circulation.**



Caution

- *For single sterile shunt bypass line assemblies. Do not use the shunt bypass line after the date printed on the package label. Use beyond the date may result in inaccurate performance.*
- *The shunt bypass lines, which are supplied sterile, will remain so if the package is unopened and undamaged.*
- *Secure all connections on the shunt bypass line with tie-bands.*

System Overview

CDI Hematocrit/Saturation Cuvette

The CDI H/S Cuvette is a flow-through device inserted directly into the extracorporeal circuit. The CDI H/S Cuvette is for a single use only. It is supplied sterile and individually packaged for incorporation into the circuit at the time of use, or it can be supplied non-sterile to tubing pack manufacturers for preconnection.

The CDI H/S Cuvette contains an optical window that provides a means of consistent optical connection between the CDI H/S Probe and the CDI H/S Cuvette. A magnet placed in the CDI H/S Cuvette provides verification of a correct connection between the CDI H/S Probe and the CDI H/S Cuvette.

Note: When the CDI H/S Cuvette is inserted into the circuit, the optical window should be pointing down. This minimizes interference from intermittent air bubbles in the line.

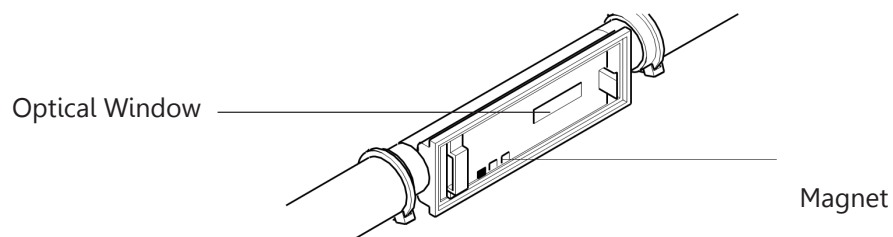

Warning

- ✦ **Aseptic technique must be used when adding the CDI H/S Cuvette to the circuit. End caps are provided on the sterile assemblies at each end of the cuvette to protect the blood pathway from contamination prior to insertion into the circuit. The CDI H/S Cuvette remains sterile so long as the package is unopened and undamaged. Each CDI H/S Cuvette has a recommended shelf life indicated by the lot number expiration date printed on each package. For additional information, refer to the CDI H/S Cuvette instructions for use.**

System Overview



Warning

- ✦ **Maintain adequate levels of anticoagulation during extracorporeal circulation by monitoring activated clotting time (ACT) or another appropriate measurement.**
- ✦ **Do not attempt to re-sterilize the CDI H/S Cuvette. Improper sterilization can reduce system accuracy or cause the CDI H/S Cuvette to leak under pressure.**
- ✦ **Do not reuse CDI H/S Cuvettes. CDI H/S Cuvettes are intended for a single use only.**
- ✦ **The H/S Cuvettes are sterile, non-toxic, non-pyrogenic, single use devices and for use in cardiopulmonary bypass procedures for up to 6 hours.**
- ✦ **Use of certain intravascular dyes during cardiovascular surgery such as Indocyanine green (Cardio-Green) and Methylene Blue may cause inaccuracies in displayed values. Independent external blood gas and blood chemistry analysis is required for accurate determination of all measure parameters needed to guide therapeutic decisions.**
- ✦ **Elevated levels of blood substances including irregular cell morphologies, protein levels, plasma free hemoglobin and bilirubin may interfere with blood measurements. Independent external blood gas and blood chemistry analysis is required for accurate determination of all measured parameters needed to guide therapeutic decisions.**
- ✦ **Blood conditions such as hemoglobinopathies, thalassemia and a variety of anemic conditions (sickle cell, iron deficiency, macrocytic), may affect the accuracy of hemoglobin and hematocrit measurements. Independent external analysis is required for accurate determination of these measurements as needed to guide therapeutic decisions.**
- ✦ **Use caution when administering novel pharmacological agents when the user is unfamiliar with the potential effect of such agents on the CDI sensors.**
- ✦ **Do not attempt in vivo recalibration expecting to re-align values affected by interference due to intravascular dyes or pharmacological agents; the interference may be prolonged resulting in continuing inaccuracies.**



Caution

- *Do not use a CDI H/S Cuvette after the lot number expiration date printed on the package label.*
- *The CDI H/S Cuvette tubing connections should be secured with tie-bands.*

System Overview

External Data Modules

The CDI OneView System is designed to communicate with three other types of medical devices: heart-lung machines (HLMs), regional oximetry devices and data management system (DMS) equipment. Each module has two connectors, a serial communication port that links the module to another medical device and a USB port to connect with the Core.

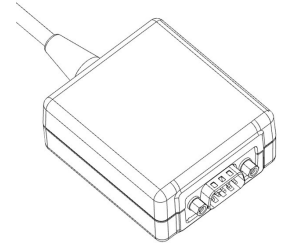

The system can be configured to acquire blood flow from HLMs. This flow is used as input in calculation of other parameters, and the flow rate value is displayed. The system can also be configured to acquire cerebral regional oxygen saturation from a regional oximetry device, and this value is also displayed. During measurement, data can be streamed to external data management system (DMS) equipment connected to an external data module.

Module for HLM

The CDI OneView System can communicate with any of the following HLM devices for flow rate acquisition:

- Terumo™ Advanced Perfusion System 1
- Terumo™ NEO System
- Medtronic Bio-Console® 560 Centrifugal Pump
- LivaNova Sorin Stöckert S5/C5®

In addition, the CDI OneView System can send out specific data to Terumo Cardiovascular HLMs listed below via the external data module:

- Terumo™ Advanced Perfusion System 1
- Terumo™ NEO System

Module for RSO₂

The CDI OneView System can communicate with any of the regional oximetry devices listed below for rSO₂ acquisition:

- Nonin SenSmart® X-100
- Edwards ForeSight Elite®
- Medtronic INVOS™ 5100c

Module for DMS

The CDI OneView System can stream case data records to any DMS equipment that uses a compatible standard serial communication protocol. The data from the Module can also be routed via serial hubs into DMS equipment.

System Overview

Flow Interface Module

The CDI OneView Flow Interface Module connects Flow Sensors to the Core. The Flow Module contains memory to store sensor identification and configuration information.

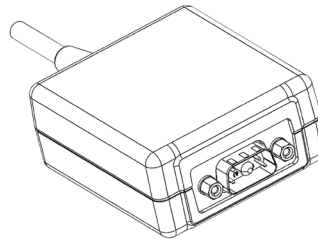

Flow Sensors

The CDI OneView Flow Sensor measures blood flow circulating in the perfusion circuit. Multiple sensor sizes are available for use with a wide variety of tubing types and sizes. The system allows connection and configuration of up to four flow sensors. The source of blood flow rate used in calculations can be customized through system configuration.

The sensors use a clamp-on mechanism to fit around different sizes of flexible tubing of the extracorporeal circuit. Sensors are labeled to indicate direction of flow to facilitate correct installation. Each sensor fits around a specific size of tubing and is suitable for a specific range of flows as indicated in the table below:

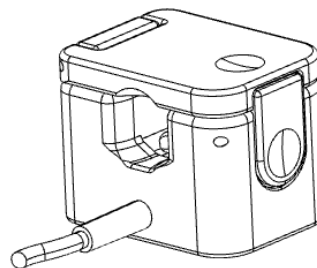

Compatible with PVC tubing:

Sensor	Inner diameter	Wall thickness	Flow rate range (mL/min)
1	3/8"	3/32"	200 – 8,000
2	1/4"	3/32"	50 – 2,500
3	1/4"	1/16"	50 – 2,500

Flow Sensor Identifiers

Flow Sensor identifiers are included within the packaging of each sensor. These color-coded identifiers can be wrapped around a Flow Sensor cable to associate the sensor with its corresponding readout on the Display.

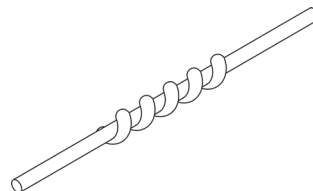

System Overview

CDI Display Bracket

The CDI Model CDI781 Display Bracket attaches to a standard heart-lung machine pole and can accommodate one Display. The Display attaches to the bracket for mounting and dismounting, and it can be adjusted in all four directions.

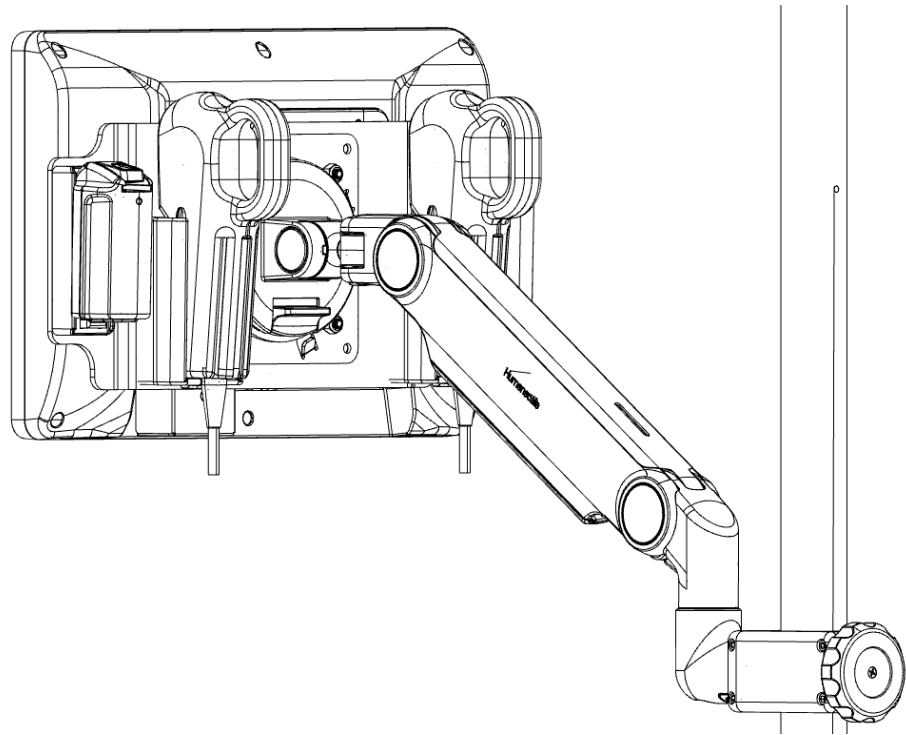

CDI Core Bracket

The CDI Model CDI780 Core Bracket attaches to a standard heart-lung machine pole and can accommodate one Core. The Core attaches to the bracket for mounting and dismounting, and it can be positioned vertically or horizontally on the pole.

The Core Bracket includes four thumbscrews that attach the mounting plate of the Core Bracket to the back of the Core.

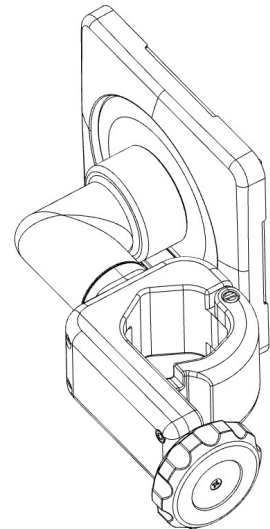

System Overview

CDI Calibrator Bracket

The CDI Model CDI783 Calibrator Bracket attaches to standard heart-lung machine poles and can accommodate one Calibrator. The Calibrator slides onto the bracket for mounting and dismounting. The bracket can be positioned vertically or horizontally on the pole.

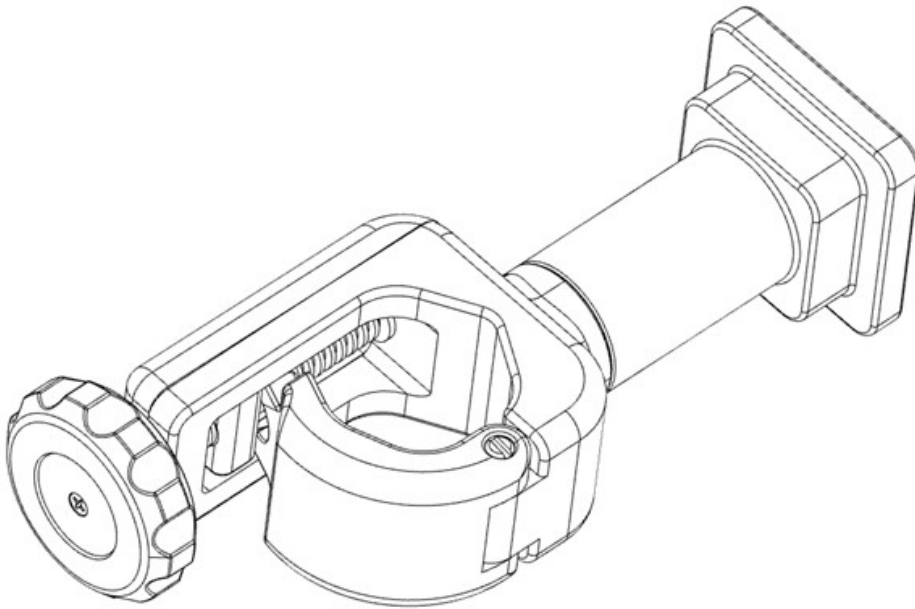

CDI BPM Bracket

The CDI Model CDI782 BPM Bracket attaches to standard heart-lung machine poles and can accommodate one or two BPM assemblies. The BPM assembly slides onto the bracket for mounting and dismounting. The bracket can be positioned vertically or horizontally and at varying lengths from the pole.

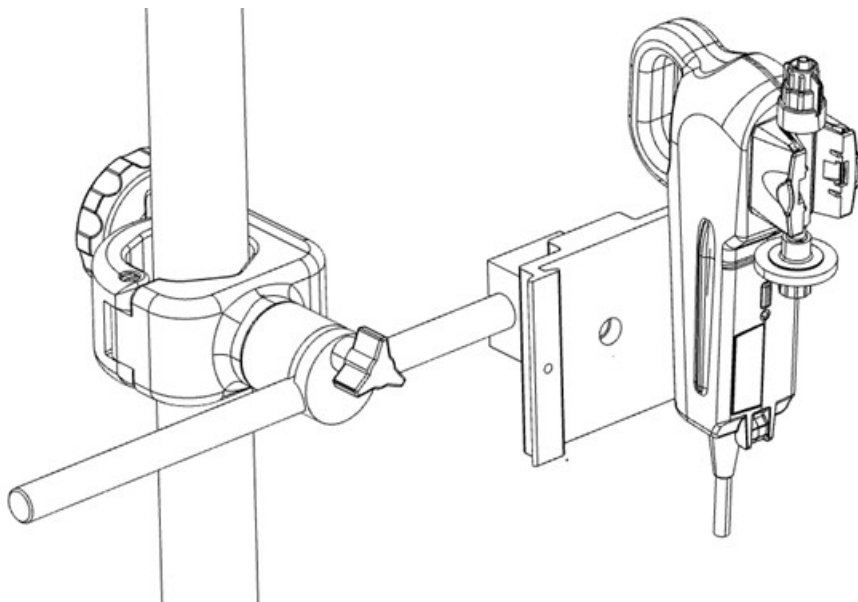

System Overview







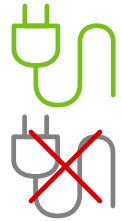





Battery Power

The CDI OneView System comes with a 14.4 V rechargeable lithium-ion battery for backup power.

The toolbar shows battery charge status and how many minutes are remaining. When the system is plugged into AC power, the plug indicator turns green and the battery status is shown as grey. When the system is running on battery power, the plug indicator shows a red X and the battery icon has green, yellow or red indicator lines to show approximately how much battery time is remaining.



The battery time remaining is affected by the type and number of modules currently connected to the system. A fully charged battery will provide at least 25 minutes of continuous system operation with the maximum number of connected modules. To recharge the Core's battery to its maximum, it must be plugged into an AC outlet for at least four hours. The system does not need to be turned on for the battery to charge. See below for the battery charge indicator states:

		Full Charge + Plugged in
		25 minutes
		20 minutes
		15 minutes
		10 minutes
		5 minutes
		System Shutdown
On AC Power	On Battery Power	

Note: The system cannot be powered on and gas calibrations cannot be performed while the system is on battery power.

Note: Battery life is affected by its age and total number of charging cycles. The system will notify the user if the battery capacity is reduced to where it may no longer support the minimum 25 minutes of backup capability. Call Terumo Cardiovascular Technical Service if you are notified that the battery needs to be replaced.

Note: There is additionally a real-time clock backup battery in the Core that maintains the system time and date. It is a lithium cell designed to last the service life of the product and is not intended to be replaced during its expected service life. As such it is a non-serviceable item.

Initial Assembly and Admin Setup

This chapter details how to set up the hardware, establish module connections, start up the system and configure administrative settings for the CDI OneView System.

System Hardware Assembly

The CDI OneView Display, Core, Calibrator and BPM each have brackets that attach to a heart-lung machine. This section provides instructions on how to set up these brackets and assemble the system hardware.

Core Setup

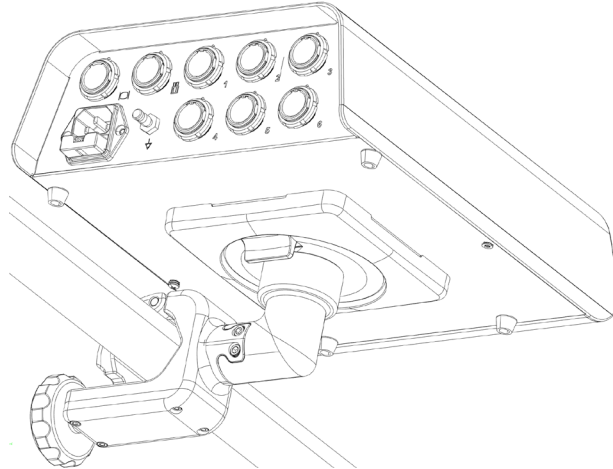

To assemble the Core, follow the steps below:

1. Depress the quick disconnect lever and remove the mounting plate and mounting cover from the mounting disk.
2. Remove the mounting plate cover from the mounting plate.
3. Use the four included thumbscrews to attach the mounting plate to the Core using the outermost holes.

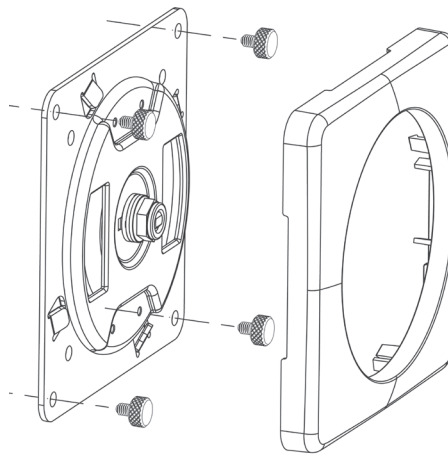

4. Snap the mounting plate cover back onto the Core.
5. Close the pole clamp around an HLM pole, then tighten the knob clockwise.

Initial Assembly and Admin Setup

6. Ensure the bracket is securely attached before proceeding.
 7. Tilt the Core to align the notches on the mounting disk with the mounting plate, then press the Core until it is firmly in place.
 8. Ensure the Core is securely attached to the bracket before proceeding.
 9. Inspect the three-prong power cable to ensure it is undamaged.
 10. Connect the female end of the power cable to the Core, then plug the male end into a grounded power outlet.
- The Core can rotate freely on the bracket.

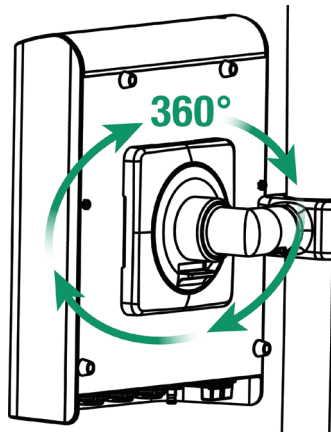

- To disengage the Core from the bracket, hold the Core securely in one hand, then squeeze the quick disconnect lever on the bottom side of the bracket.

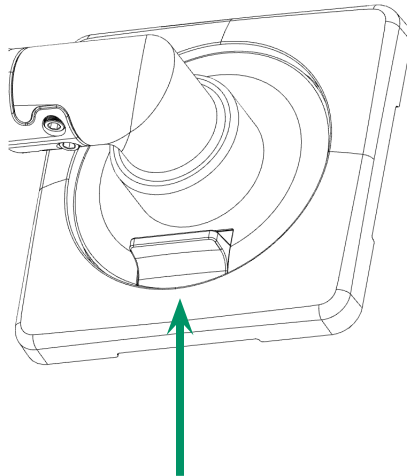

Initial Assembly and Admin Setup

Display Setup

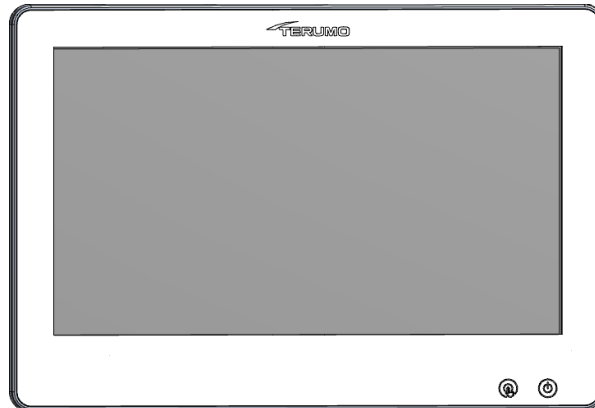

Warning

- ✦ **The Display Bracket pole clamp cannot be placed on a horizontal pole. It must only be placed on a vertical pole.**

To assemble the Display, follow the steps below:

1. Close the pole clamp around an HLM pole, then tighten the knob clockwise.
2. Ensure the bracket is securely attached before proceeding.

Note: The Display Bracket is under tension and will be at its highest position until the Display is attached.

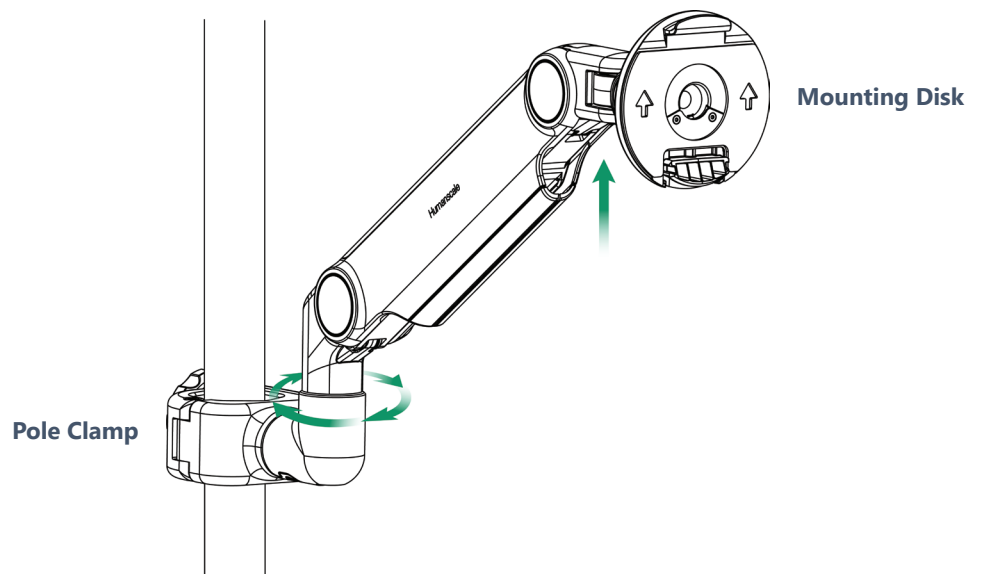

Initial Assembly and Admin Setup

3. Tilt the Display to align the notches on the mounting disk with the Display mount, then press the Display until it is firmly in place.

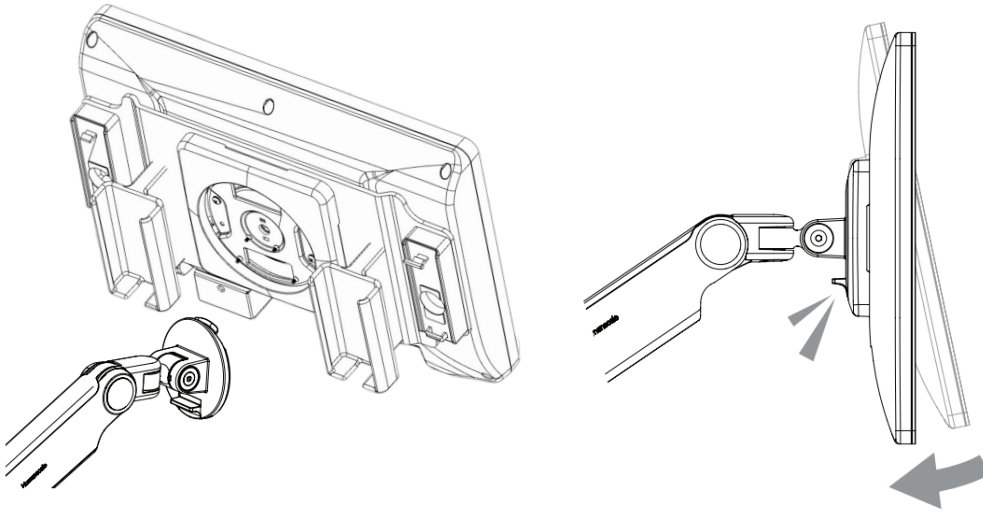

4. Ensure the Display is securely attached to the bracket before proceeding.
5. Connect the right-angle end of the Display cable to the bottom of the Display by aligning the red alignment dots and pushing until it clicks. The Display cable can be routed through the Display Bracket, if preferable.
6. Connect the other end of the Display cable to the Display port on the back of Core by aligning the red dots and pushing until it clicks. See [Chapter 1, "Core"](#) for Display port location.

- The Display can swivel and tilt freely on the bracket.



Warning

- + **Before removing the Display from the Display Bracket, raise the bracket to its highest position. The bracket is under tension and may spring upward if not already at its highest position when the Display is removed.**
- + **Do not push down on the Display Bracket while removing the Display.**

- To disengage the Display from the bracket (A), hold the Display firmly in one hand, then squeeze the quick disconnect lever (B) on the bottom side of the bracket.

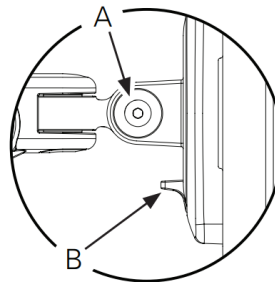

Warning

- + **Do not roll equipment over the cables of the CDI OneView System. Mishandling can cause damage and deterioration of system performance.**

Initial Assembly and Admin Setup

Calibrator Setup

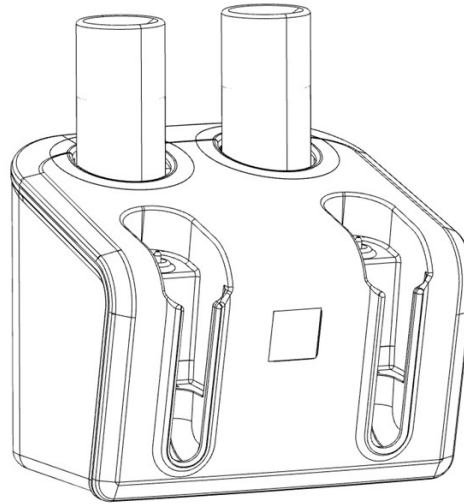

The CDI OneView Calibrator requires one Gas 1 bottle and one Gas 2 bottle to perform a gas calibration of the sensors.

1. Close the pole clamp around an HLM pole, then tighten the knob clockwise.
2. Ensure the bracket is securely attached before proceeding.
3. Align the back of the Calibrator with the top of the bracket, then slide the Calibrator downward into place.

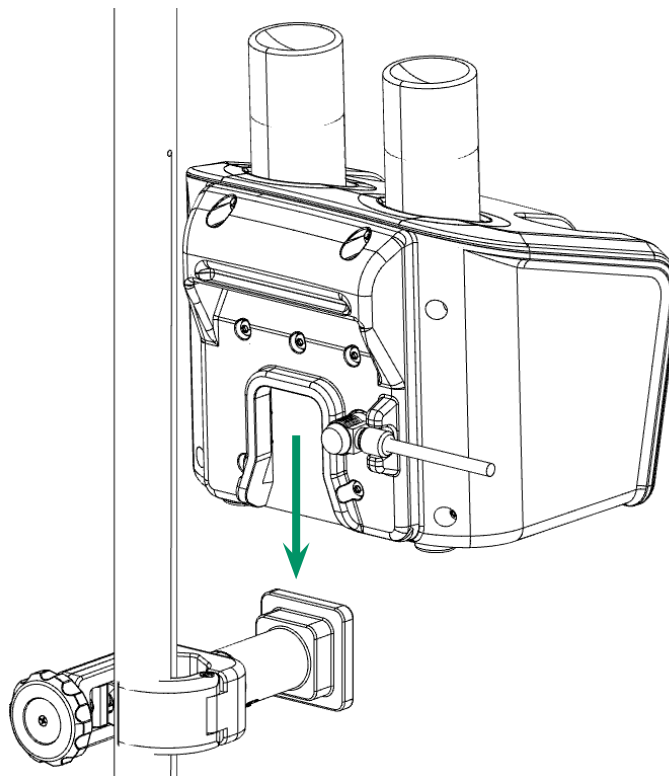

Initial Assembly and Admin Setup

4. Connect the right-angle end of the Calibrator cable to the back of the Calibrator by aligning the notch and red dots, then pushing until it clicks.
5. Connect the other end of the Calibrator cable to the Calibrator port on the back of the Core by aligning the red dots and pushing until it clicks. See [Chapter 1, "Core"](#) for Calibrator port location.
6. Check the expiration dates printed on the labels on the gas bottles.
7. Remove the caps from the calibration gas bottles.
8. Place the Gas 1 bottle into the yellow Gas 1 receptacle and twist the bottle clockwise. Do not overtighten.
9. Place the Gas 2 bottle into the blue Gas 2 receptacle and twist the bottle clockwise. Do not overtighten.

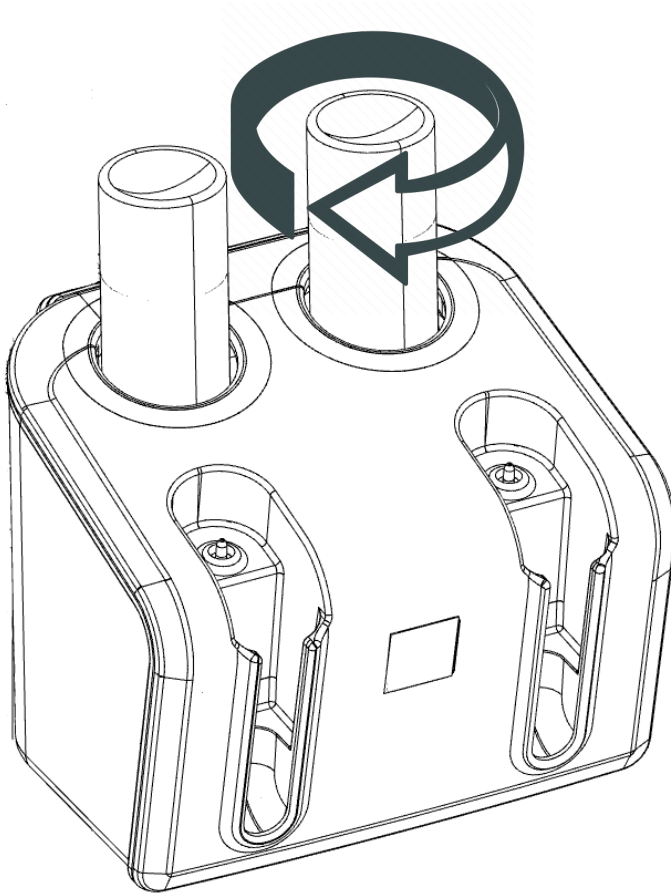

Note: During the calibration procedure the Calibrator can either be securely attached to the Calibrator Bracket or placed on a flat surface.

Initial Assembly and Admin Setup



Caution

- *Use only CDI Gas 1 and CDI Gas 2 calibration gas bottles intended specifically for use with the CDI Model 740 Calibrator. Use of any other gases will result in calibration failure or yield inaccurate calibration results, causing inaccurate system performance.*
- *Do not use the gas bottles after the recommended expiration date. Use of the gas bottles after that date may result in inaccurate calibration values.*
- *Contact with combustible material may cause fire.*

Note: Terumo Cardiovascular recommends that the gas bottles remain in the Calibrator at all times to avoid introducing debris into the calibrator. If the Calibrator is to be stored for a long period of time, remove the gas bottles but ensure the openings are kept covered.

Note: The Calibrator must be placed in an upright position to ensure correct calibration.

Note: CDI gases are contained in disposable cylinders. These non-returnable cylinders contain nontoxic, non-flammable gases and gas mixtures.

To dispose of a gas bottle:

1. To release residual pressure of the gas bottle, press inside the centermost point of the threaded portion of the valve. For gases or mixtures containing less than 21% oxygen, this should be done in a well-ventilated area to avoid asphyxiation by displacement of oxygen.
2. Remove or obliterate markings that indicate the bottle contains hazardous material.
3. Discard the bottle as you would other metallic or hard goods trash as permitted by local authorities, rules or regulations.

Note: To dispose by recycling, the valve must also be removed from the bottle, as it is made from a different type of metal.

Initial Assembly and Admin Setup

BPM Bracket Setup

The CDI BPM Bracket should be placed on the HLM pole nearest the shunt/purge line used for shunt sensing.

1. Close the pole clamp around an HLM pole, then twist the knob clockwise. Ensure the bracket is securely attached before proceeding.
2. Adjust the plate so that the BPM will be in a convenient position to route the shunt line tubing through the Shunt Sensor.

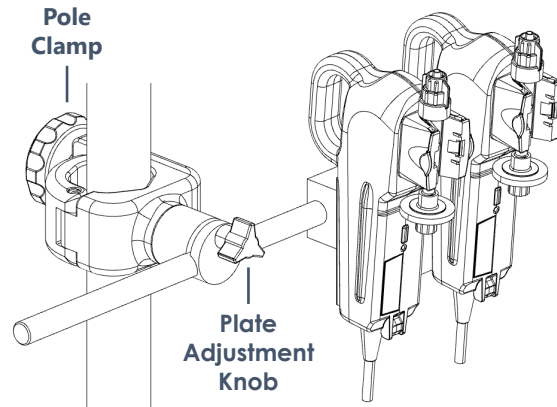

The BPM Bracket can be adjusted in the following ways:

- The bracket length can be changed using the plate adjustment knob.
- The plate location can be changed by using the plate adjustment knob.
- The rotation of the plate can be changed by pulling the plate away from the bracket and rotating the plate 90° or 180° right or left.

Note: The plate will lock into place in either a vertical or horizontal orientation.

Initial Assembly and Admin Setup

Module Connections

Prepare all the module connections to the Core.

1. Connect desired modules [BPM(s), H/S(s), External Device Module(s) and Flow Interface] to any module ports (1-6) on the back of the Core by aligning the red dots and pushing until they click.
2. Connect serial cable(s) to the appropriate Module(s) and position them as desired.
3. Connect Flow Sensor cable(s) to the Flow Interface Module and position the Flow Sensor(s) as desired.
4. Route all cables to minimize risk of damage and exposure to spills.

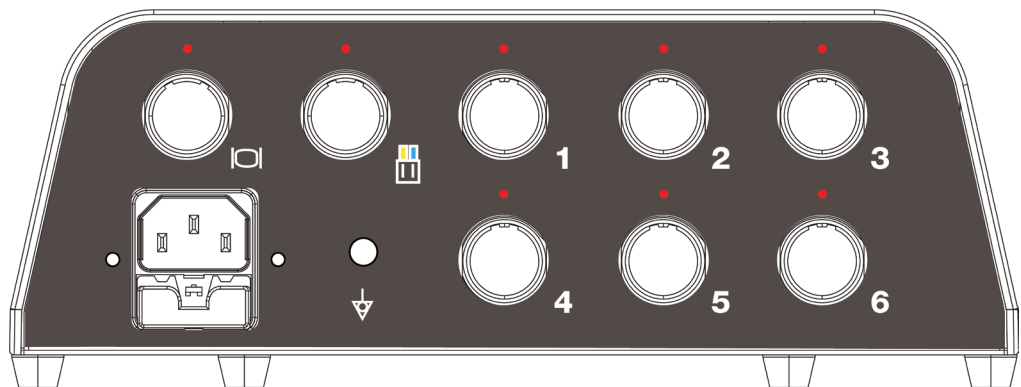

Warning

- ✦ **Do not position the Core or any component, module or mounting assembly in a location that will hinder disconnecting the AC power cord from the Core.**
- ✦ **Ensure that all cables are undamaged and properly connected.**
- ✦ **Secure all excess cabling to prevent movement hazards and prevent inadvertent disconnections.**
- ✦ **Do not damage or stress any cables.**
- ✦ **The use of accessories and cables other than those specified by the manufacturer could result in increased electromagnetic emissions and/or decreased electromagnetic immunity.**

Initial Assembly and Admin Setup

Module Storage

When the system is not in use, always leave the BPM(s) and H/S(s) in their designated holders on the back of the display. Storing the modules in this way protects their optical surfaces.

1. The BPM Probes are stored on the inner left and right holders on the back of the Display. While holding the sensor side towards the Display, align the grooves on both sides of the probe with the top of the holder, then slide downwards until the probe is flush against the bottom of the holder.
2. The H/S Probes are docked on the outer left and right mounts on the back of the Display. While holding the sensor side facing towards the Display, insert the bottom tab into the receptacle and gently press the probe into the mount until it clicks into place.

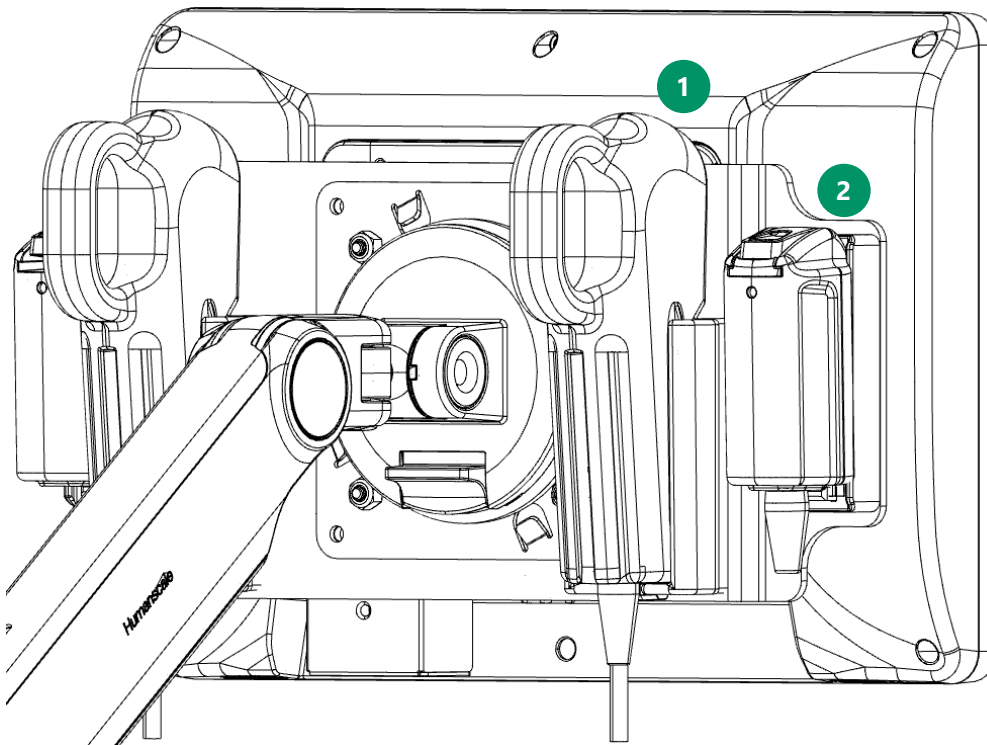

Caution

- To avoid damage to the BPM and H/S, do not use excessive force while adjusting the display. Avoid contacting the BPM holder with the display bracket.
- There are protruding edges on the H/S mounts.

Initial Assembly and Admin Setup

System Startup

Before switching on the system, ensure the Core LED is steady white and not flashing. Also ensure the BPM and H/S Probes are docked in their designated mounts on the back of Display, which is required for the system diagnostics and module self-tests to run automatically. These tests verify the function of the display electronics and check for electronic/optical drift in the modules that could result in calibration failure or reduced accuracy. These checks should be done completely and routinely prior to each use of the CDI OneView System.



Caution

- After shutting down the system, ensure the Core and Display LEDs are no longer flashing before powering on the system again. Flashing LEDs indicate the system is not ready to power on.

1. Ensure that the Display cable is properly connected to the Core and that the Core is plugged into a power outlet.
2. Press and hold the power button for one second on the front of the Display. The startup sequence begins, and the following screen appears:

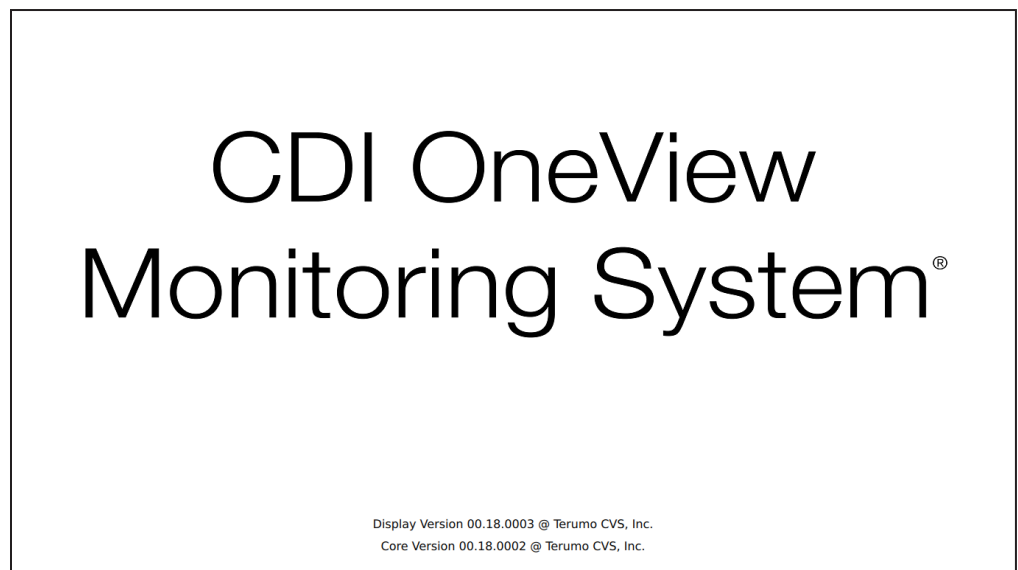

The software version numbers for both the Core and Display are listed at the bottom of the window.

Note: Depending on the configuration, your device's screens will look different from the examples provided throughout this manual.

Initial Assembly and Admin Setup



Administrator Setup

An admin account allows full setup of the CDI OneView System for use. Only accounts with administrative privileges can create new case profiles and configure default system settings.

The rest of this chapter details how to create new admin accounts, as well as how to create and manage normal user accounts. It also explains the systems that are only available to admin accounts and provides instructions on how to configure these settings.

Note: If an admin account has already been created and administrator credentials are no longer accessible, call Terumo Cardiovascular Technical Support to create a new admin account.



Initial Assembly and Admin Setup



First Time Administrator Setup

All new CDI OneView Systems require an admin account for first-time setup.

New Admin Login

Username

New Password

Confirm Password

Password Rules:

- Minimum 6 characters

To create a new admin login:

1. Type in a username and password.
2. Retype the same password for confirmation.
3. Tap *Submit*. If the passwords match, the User Login window will appear.
4. Retype the username and password.
5. Tap *Submit* to log in.

Note: Usernames cannot include special characters.

A barcode scan can be used instead of typing a password:

1. Type in a username.
2. Tap the barcode button:
3. Scan the barcode by placing it below the Display.
4. Tap the barcode button again for password confirmation.
5. Scan the barcode again by placing it below the Display.
6. If the password barcode matches, the User Login window will appear.
7. Retype the username.
8. Tap the barcode button and rescan by placing the barcode below the Display.
9. Tap *Submit* to log in.



Initial Assembly and Admin Setup



System Settings

System Settings allow the admin to configure the following:

- User Management
- Security
- Language
- Sound

Tap the *Admin* button in the bottom left corner of the screen to access System Settings.

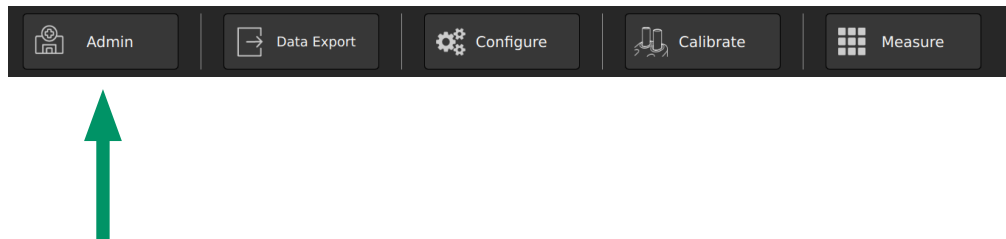

System Settings Tabs

After tapping the Admin button, the following tab selector appears on the upper left of the screen. Tap any menu item to go to that tab.

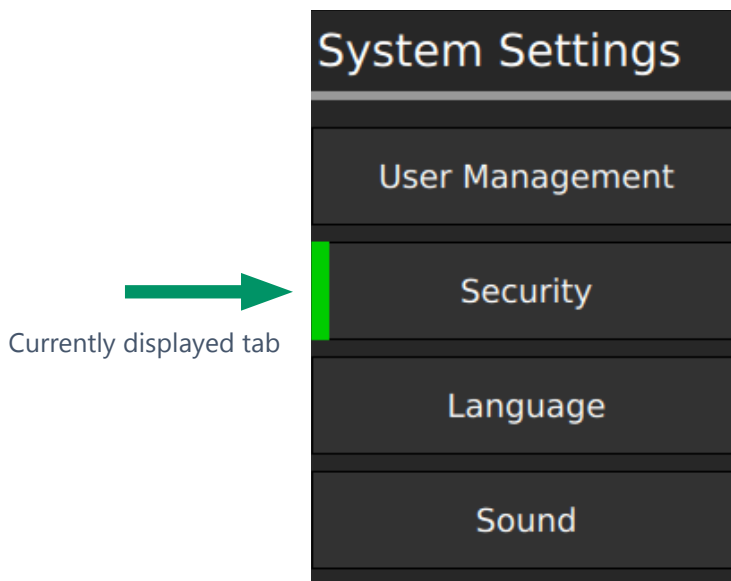

Initial Assembly and Admin Setup



User Management (Optional)

The **User Management Tab** allows admins to create new users, edit passwords for existing users, and assign users a permission level of admin or normal user.

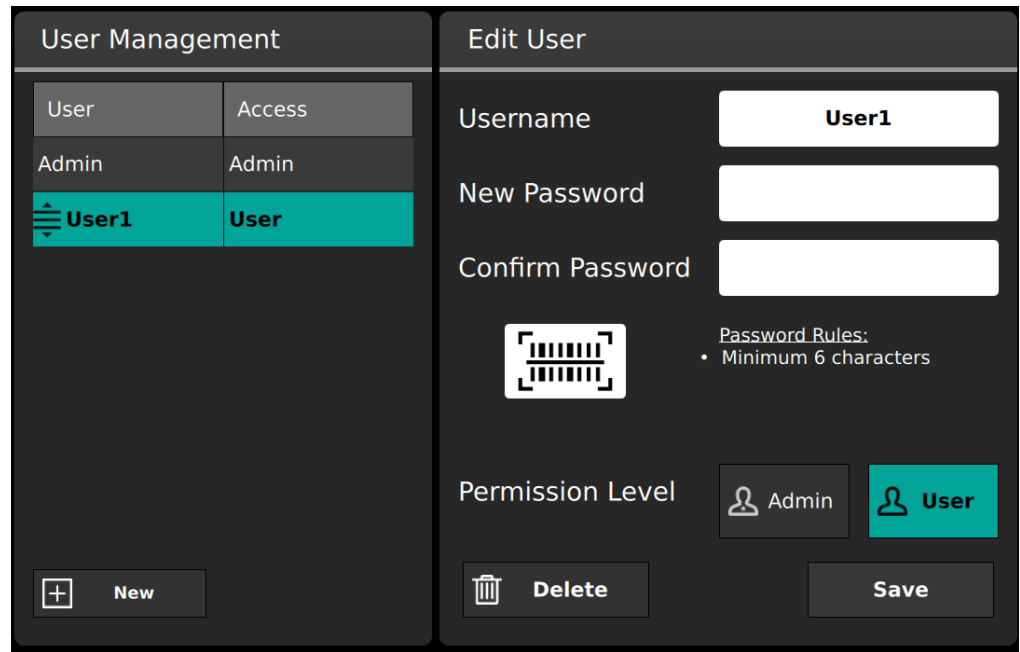

- To create a new user, tap *New*. Enter the username and password, then reenter the password to confirm it. (A barcode can also be used instead of typing a password: see [Chapter 2, "Administrator Setup"](#)). Set the permission level of the user, then tap *Save*.
- To edit an existing user, select the user from the **User Management** list. Make any desired changes to the username, password or permission level, then tap *Save*.
- Permission Level toggles a user between admin and normal user permissions. Admin permission grants full access to all controls and settings of the system.
- To delete a user, select the desired user from **User Management** and tap *Delete*.
- To reorder the list of users, press and hold a username to move it up or down.
- The complexity rules displayed under Password Rules is determined by the current Password Complexity configuration in the **Security Tab**.

Note: User access control must be toggled on in the **Security Tab** to enable logging in to user accounts.

Note: Usernames cannot include special characters.



Initial Assembly and Admin Setup



Security

The **Security Tab** configures settings pertaining to user authorization.

The screenshot shows the Security Tab interface with three sections: Password Complexity, Login Requirements, and Admin Inactivity Timeout (min).
1. **Password Complexity**: Three buttons labeled 'High', 'Medium', and 'Low'. The 'Low' button is highlighted in teal. Below the buttons, the following text is displayed:
Low: Passwords shall minimally contain 6 characters
Medium: Passwords shall minimally contain 8 characters with 1 capital letter and 1 number
High: Passwords shall minimally contain 8 characters with 1 capital letter 1 number, and 1 special character
2. **Login Requirements**: A toggle switch for 'User Access Control (require users to log in)'. The switch is currently in the 'On' position, with 'Off' written in green below the line.
3. **Admin Inactivity Timeout (min)**: A table with two columns. The first column is 'Minutes until timeout (5-90)' and the second column is '60'. To the right of the '60' is a toggle switch for 'Enabled/Disabled'. The switch is currently in the 'Enabled' position, with 'Disabled' written below the line.

- Password Complexity can be set to High, Medium, or Low.
- Login Requirements for user access can be toggled on or off.
- Admin Inactivity Timeouts can be disabled or enabled along with a preset duration. If enabled, the Admin Inactivity Timeout will automatically log out the admin after the specified period of time.
- Scroll to the bottom of the **Security Tab** and tap *Reset* to delete all case profiles and configurations.

The screenshot shows the 'Reset all settings' screen. It has a title 'Reset all settings' at the top. Below the title, there is a description: 'Removes all user defined configuration including all profiles and access/log in info'. To the right of the description is a button labeled 'Reset' in green text.

Note: *Reset* will permanently delete all settings. This feature is intended for use when decommissioning a device.



Initial Assembly and Admin Setup



Language

The **Language Tab** sets the default language of operation for the CDI OneView System.

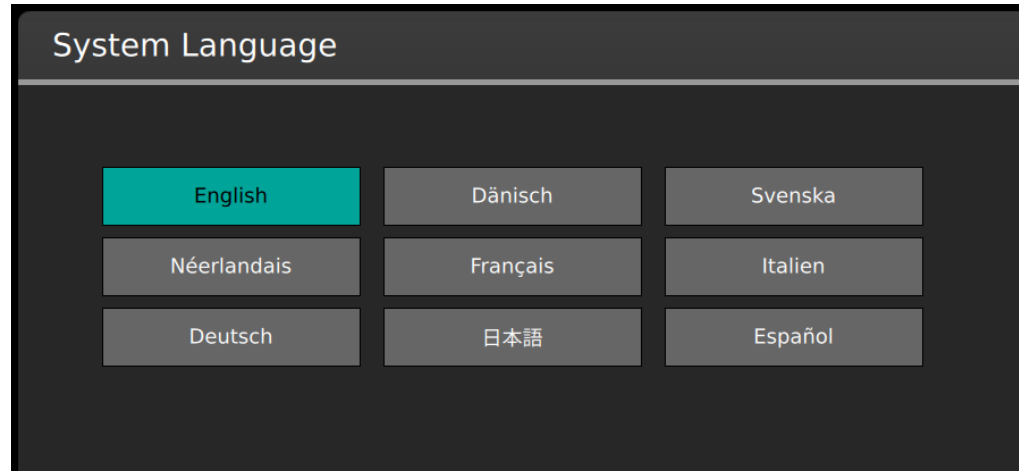

Sound

The **Sound Tab** allows the admin to enable or disable the global alarm mute.

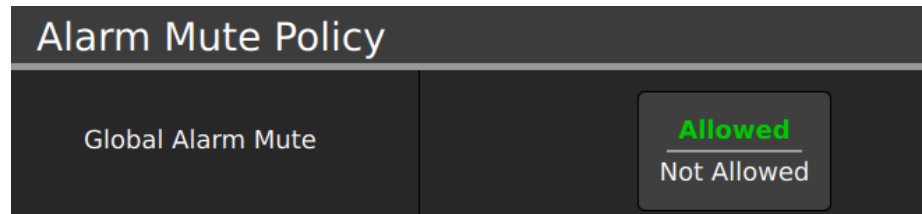

- When enabled, alarms can be muted during an active case.
- When disabled, alarms cannot be muted at any time.

Note: Alarms can always be paused regardless of the Global Alarm Mute setting. An alarm volume pause will temporarily stop the alarm sound until another alarm is triggered.

Tap the *Back* button at the bottom left to return to the Home Screen.

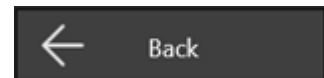

Case Profile Configuration

This chapter provides instructions on customizing case profiles for the CDI OneView System. This includes information on the following:

- The toolbar icons
- Pop-up messages and the message center
- The battery status and AC power indicators
- Modifying case profiles
- Dark/Light mode

The Toolbar

From the toolbar at the top of the screen, the user can access the following functions:



1. User login
2. Message center
3. Volume indicator
4. Time/Date
5. Power indicator/Battery status

User Login

Select a username and enter its password to login.

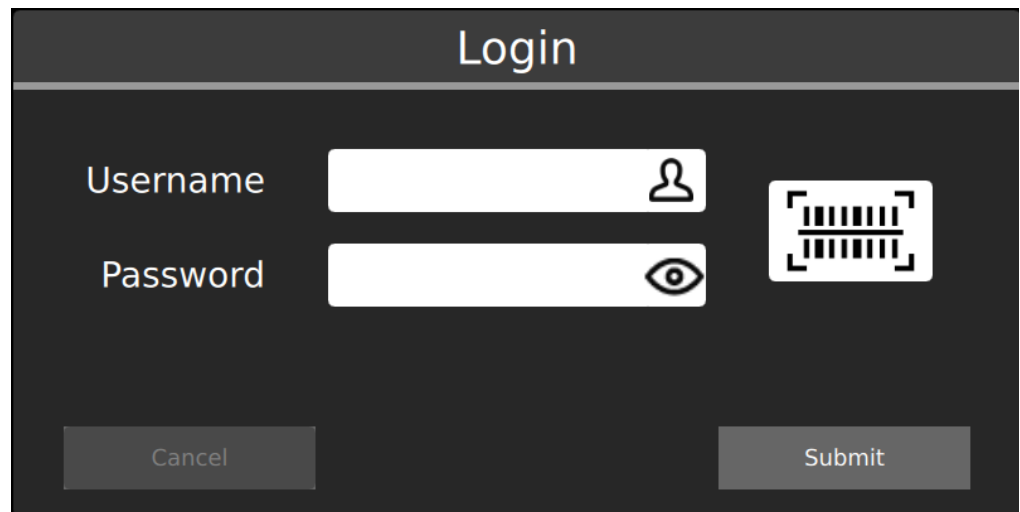

A barcode scan can be used instead of typing a password, if enabled by the admin (see [Chapter 2, "Administrator Setup"](#)):

1. Select username.
2. Tap the barcode button: 
3. Scan the barcode by placing it below the Display.
4. Tap *Submit* to log in.

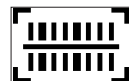

Case Profile Configuration

Pop-Up Messages

Pop-up messages are short-duration dialog windows that confirm an action has been either successful or unsuccessful. These are colored in green or orange and show either checkmarks or error messages. They stay active on screen for two to five seconds.



Successful action

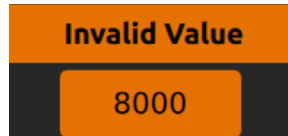

Unsuccessful action

Message Center

The Message Center shows the most recently triggered technical alarm or notification at the top center of the screen.



When the Message Center is tapped, a window will appear with a list of current technical alarms and notifications. Technical alarms will have a yellow circle in accordance with Medium Priority alarms (see [Chapter 6, "Error Messages and Conditions"](#) for more information).

Technical Alarms will persist at the top of the list. All other messages appear with a grey circle and are listed from newest to oldest. When higher priority messages appear in the Message Center, lower priority messages will only be visible after tapping the Message Center to expand it.

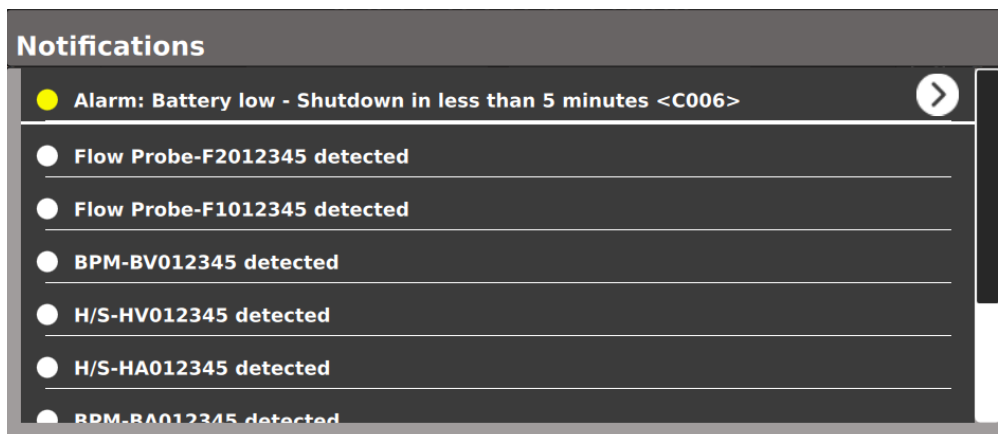

Messages with a caret can be tapped to view additional information.

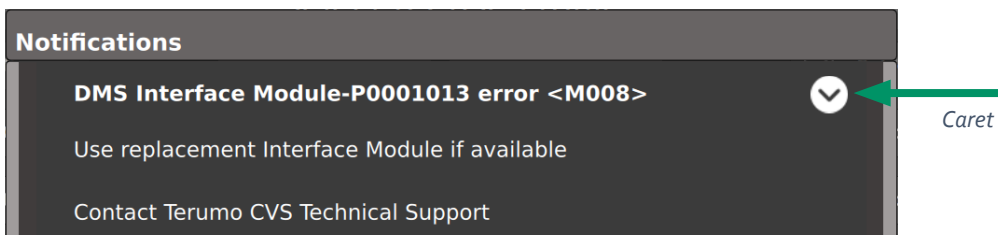

Case Profile Configuration

Volume Indicator

This icon indicates whether the alarm volume is enabled, paused or muted. For further information on configuring the alarm volume settings, see [Chapter 5 "Volume Settings."](#)



On



Paused



Muted



Time/Date

To change the date or time:

1. Tap the time/date area to activate the number pad.
2. Select desired date format.
3. Tap *Save*.

The time can be set in increments of one minute.

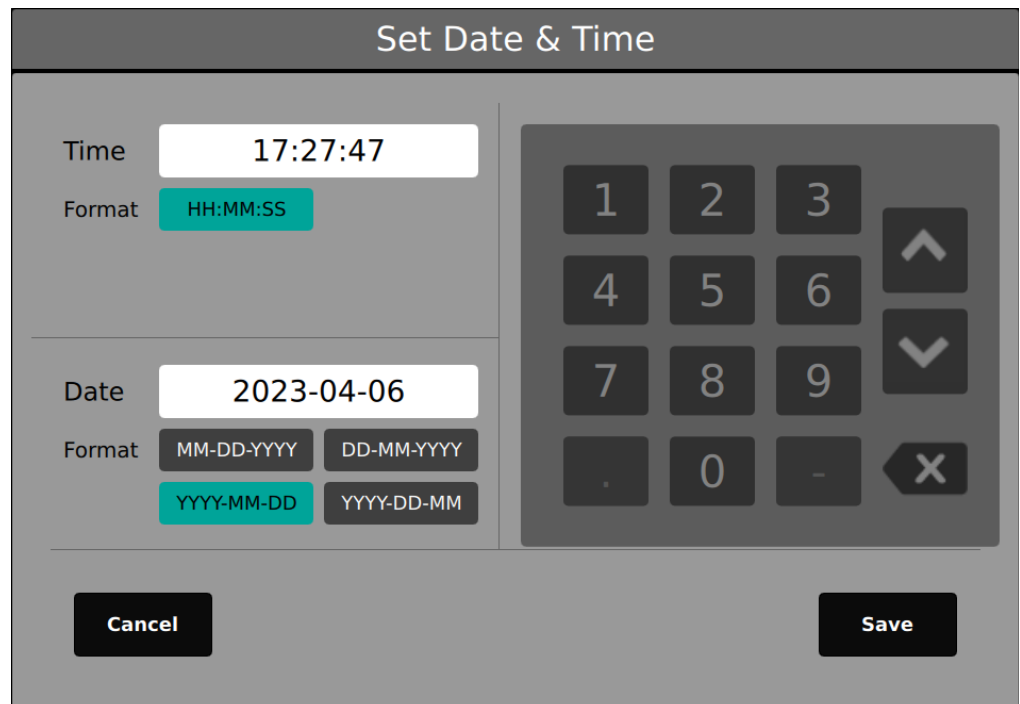

Note: The time/date cannot be changed while in Measurement Mode.

Case Profile Configuration



Case Profile Management

Case profiles can be created, deleted and configured by admin users. Case profiles provide preset configurations to suit users' preferences, as well as to meet the differing requirements of various cases encountered by an institution.

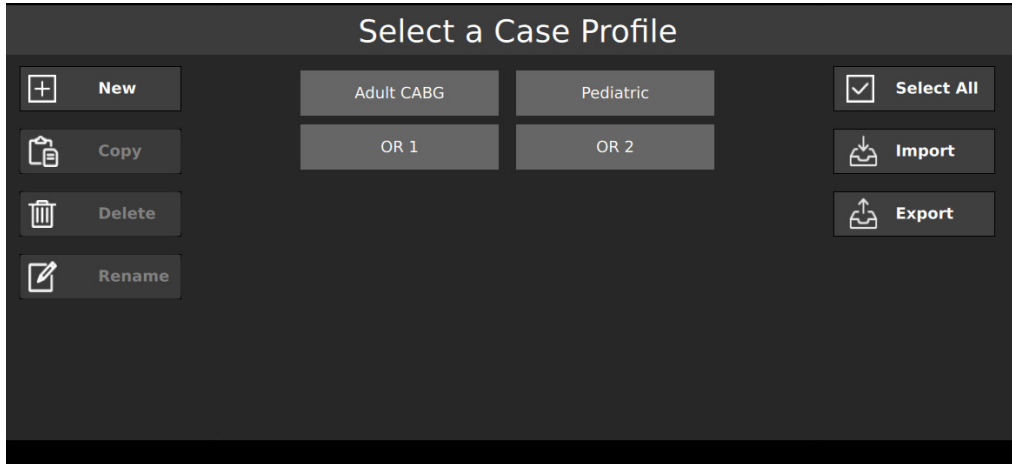

Case profile menu for admin users

- To create a new case profile, tap *New*, enter a case profile name and tap *Save*. The **Sensor Connections Tab** will appear. Proceed to configure sensor connections and display layout on this tab, then select the Flow Source for Calculation on the **Data Options Tab**. All other tabs are optional.
- To copy a case profile, tap *Copy*.
- To rename a case profile, tap *Rename*.
- To delete a case profile, tap *Delete*.

Note: The system can support up to 12 case profiles.

Import and Export Case Profiles

Case profiles can be imported from and exported to a USB drive and/or the System (Core).

- To select all case profiles, tap *Select All*.
- To import a case profile, select all desired case profiles and tap *Import*.
- To export a case profile, select all desired case profiles and tap *Export*.

When importing or exporting case profiles, this window will appear to specify using either a USB drive or the System (Core). To use a USB drive, one must be connected to the USB port on the Display and detected by the system.

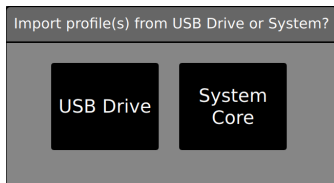

Case Profile Configuration

Modify a Case Profile

To modify a case profile, select the desired case profile, then tap *Configure* at the bottom of the screen.

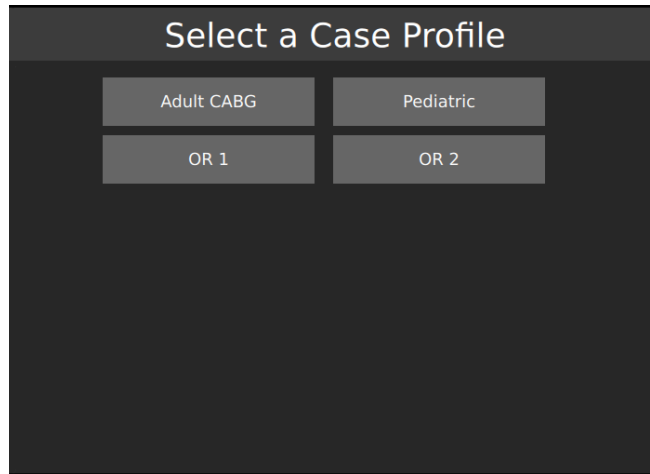

Case profile menu for normal users

Note: A message will be displayed if the selected profile has been modified by an administrator since the last time it was used.

.....

Case Profile Configuration

After creating a case profile or tapping the *Configure* button, the following tab selector appears on the upper left of the screen. Tap any menu item to go to that tab.

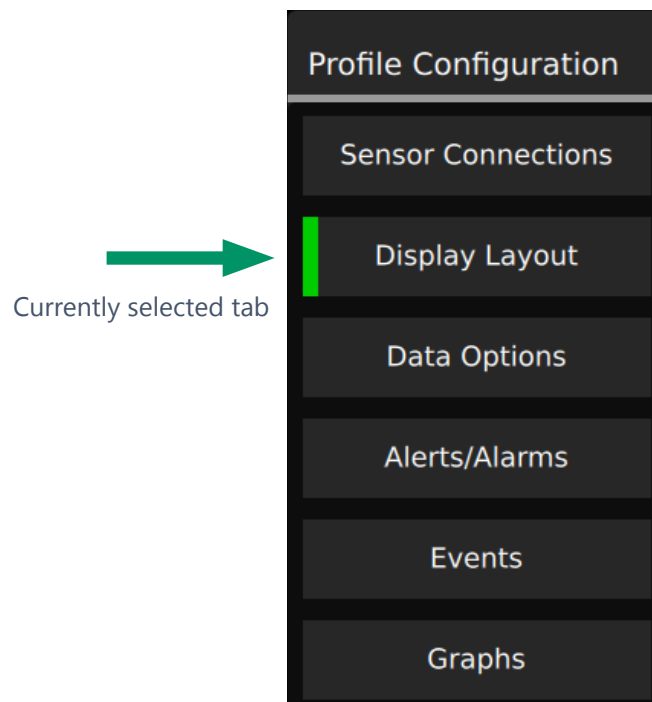

Case Profile Configuration

Sensor Connections

The **Sensor Connections Tab** shows the modules currently connected to the Core and allows the user to configure what modules will be visible during measurement. Use the scrollbar on the right to navigate through all connections.

Module types are listed in the following order:

- Arterial and Venous BPMs
- Arterial and Venous H/Ss
- Flow Sensors
- HLM
- Oximeter

BPM - Arterial	NONE	B0050044	B0050083
BPM - Venous	NONE	B0050044	B0050083
H/S - Arterial	NONE	H0050034	
H/S - Venous	NONE	H0050034	
Q - Arterial	NONE	F0001023	
Q - Venous	NONE	F0001023	
Q - 3	NONE	F0001023	Q-3
Q - 4	NONE	F0001023	Q-4
Q - HLM	NONE	Terumo System 1	Liva Nova S5/C5 BioConsole 550/560 Terumo NEO
Oximeter	NONE	Nonin	Invos Elite

Once a module connection is made to the Core, the serial number will appear on the screen next to the appropriate category. There is no default setting for connected modules. When a module is not connected, it defaults to *NONE*.

To show the blood parameters from a sensor in Measurement Mode, assign its corresponding serial number to a sensor type (Arterial, Venous, etc.). If a BPM or H/S Probe is assigned as arterial, its LED indicator light will illuminate red. If a BPM or H/S Probe is assigned as venous, its LED indicator light will illuminate blue.

The names for the first two Flow Sensors default to *Q - Arterial* for red and *Q - Venous* for blue. The orange and green Flow Sensors can be given custom names of up to five characters by tapping the corresponding category after choosing a serial number. The color for each Flow Sensor category should match the color indicator placed on the physical sensor (see [Chapter 1, "Flow Sensor Identifiers"](#)).

For the HLM and Oximeter categories, tap the corresponding device name. Only one selection is allowed for each of these modules.

If a serial number button is greyed out, then that module has already been assigned. If a selection is highlighted in green, then the associated parameter will be available in the Display Layout Builder. If *NONE* is highlighted in green, then that parameter will not be available in the Display Layout Builder.

Case Profile Configuration

Display Layout

The **Display Layout Tab** shows the Display Layout Builder at the top of the screen, which provides a list of all available parameters previously configured in Sensor Connections. At the bottom it shows the Display Preview, which provides a preview of the current Measurement Screen configuration.

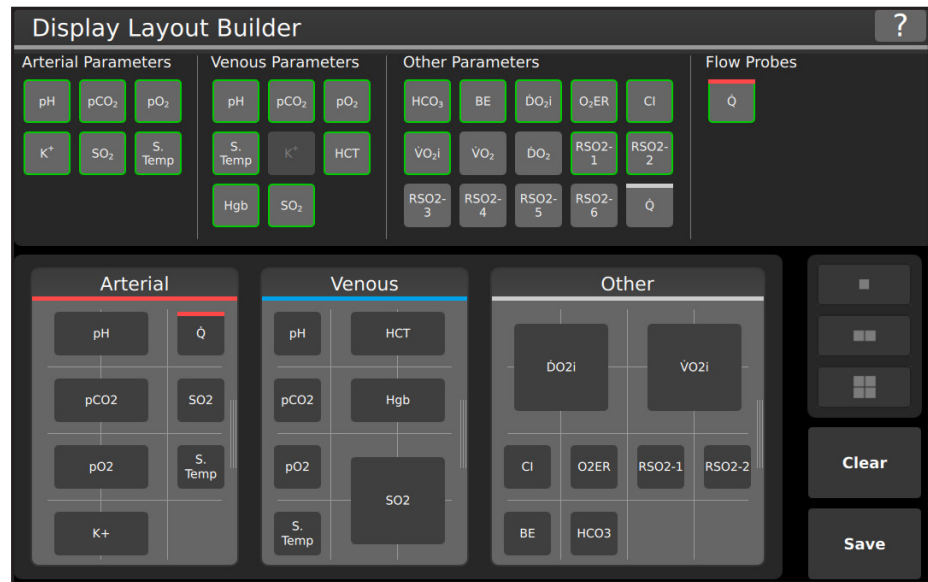

Follow the steps below to add parameters to the Display Layout:

1. Tap on the desired parameter in the *Display Layout Builder*.
2. Available cells for placement are highlighted in white in the *Display Preview*.
3. Tap an available cell to place the parameter tile.

Note: The selected parameter outlines in green in the *Display Layout Builder* to indicate it has been successfully placed.

Follow the steps below to resize parameter tiles:

1. Tap the parameter tile in the *Display Preview*.
2. Tap a resize option on the right side of the display



Tiles can be resized to 1x1, 1x2, or 2x2, depending on available space within the container. The parameter tile will resize to the right of and below the current location, if space is available.

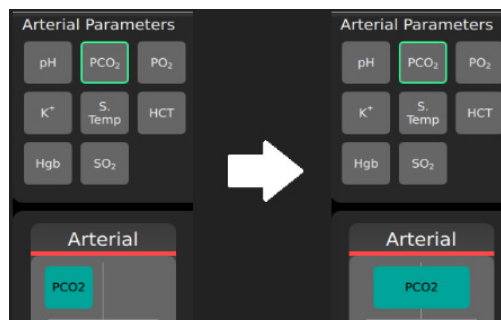

Example of a 1x1 tile resized to 1x2

Case Profile Configuration

The *Arterial*, *Venous* and *Other* containers can be resized. To resize a container, follow the steps below:

1. To expand a container, first shrink another container.
2. Touch and hold the right side of the container to initiate resizing.
3. Slide the handle left to shrink and right to expand.

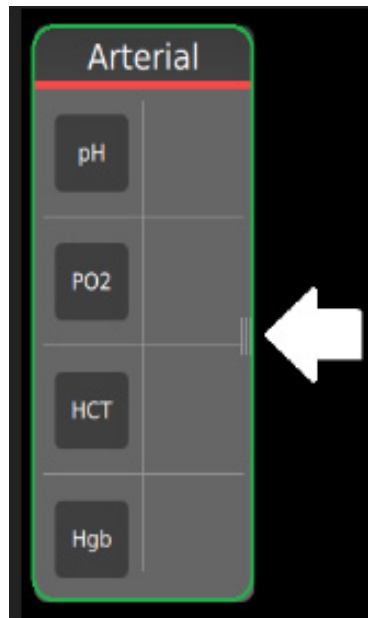

Note: The right-most column of a container must be empty to shrink the container.

Case Profile Configuration

Data Options

The **Data Options Tab** gives various choices of how data is displayed and whether certain functionality is enabled.

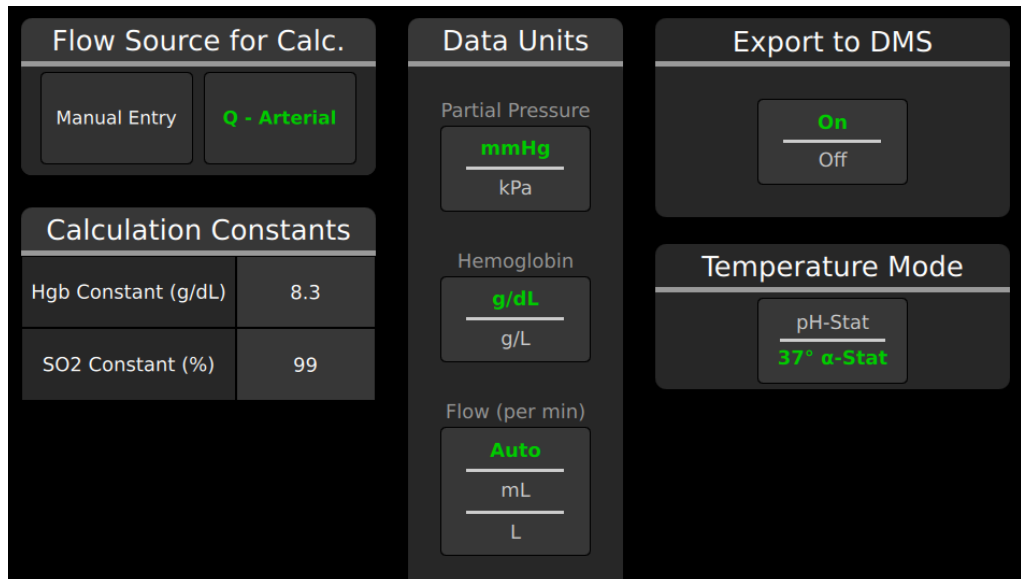

This screen has three different types of interactions:

- **Button Selection.** Tap for desired selection.
- **Toggles.** Displays the current selection highlighted in green.
- **Number pads.** Tap to input numeric value.

Flow Source for Calculation must be selected before the case profile can be saved. The setup in Sensor Connections will determine the choice of flow sources.

Calculation Constants

- **Hgb:** This value is used for the calculation of BE, VO_2 and DO_2 . Default value is 8.3 g/dL.
- **SO₂:** This constant is used for the calculation of oxygen consumption and delivery if no arterial BPM is used. The default value is 99%.

Data Units toggles partial pressure, hemoglobin and flow during measurement.

Export to DMS toggles streaming to DMS devices on or off during measurement. This option is only available if a DMS device is currently connected to the Core via a DMS Interface Module.

Temperature Mode toggles between pH-stat and α -stat default setting for the case profile.

Case Profile Configuration

Alerts/Alarms

The **Alerts/Alarms Tab** sets thresholds for the physiological parameters measured or calculated by the CDI OneView System. The parameters available depends on the modules configured in Sensor Connections. Set high and low alerts as well as alarm thresholds to notify the user when parameters fall outside of clinically relevant limits.

Set Alarm Thresholds ?

	Low Alarm	Low Alert	High Alert	High Alarm
pH	7.00	---	---	7.65
pCO ₂	35	---	---	60
pO ₂	30	---	---	65
Q̇	50	---	---	2500
pH	7.10	---	---	7.65
pCO ₂	30	---	---	55
pO ₂	85	---	---	500

Alarms

The alarms are triggered when any parameters are outside the set alarm limits. When alarms are active, the following occurs:

- A sound is emitted (unless muted).
- A flashing yellow border appears around the tile
- An arrow will indicate if the alarm is high or low.

Note: There is no inherent delay in the determination of any alarm condition.

Alerts (Optional)

Alerts are optional notifications that must be within alarm value ranges. When alerts are active the following occurs:

- The tile will display a static white border.
- An arrow will indicate if the alert is high or low.

Modifying Alerts/Alarms

1. Tap a cell to edit that value.
2. Enter a value with the number pad or use arrows to increase/decrease the value.
3. Tap anywhere outside the number pad to accept the value.
4. Once all changes are made, tap *Save* before navigating away.

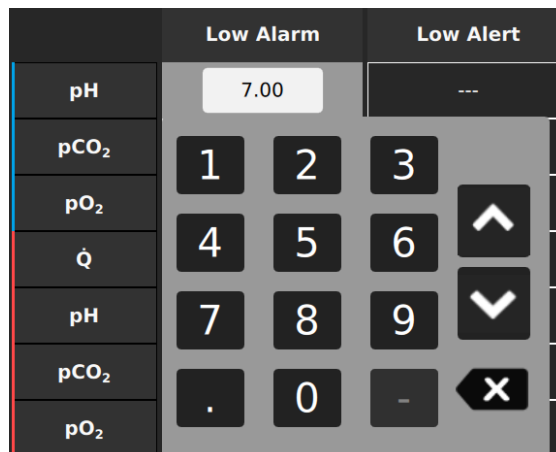

Case Profile Configuration

Reset to System Defaults resets all alarm limits to the manufacturer-defined default limits. The manufacturer-defined default limits are derived from typical clinical values that can occur during cardiopulmonary bypass for which user intervention may be required.

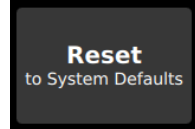

Reset to Profile Defaults resets all alert and alarm settings to the case profile defaults set by the admin. This option will not be available until a case profile has been created.

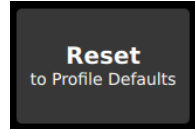

Note: Set the low alarm limit at the desired threshold for DO₂ Area Under the Curve (AUC) calculation. The threshold will appear as a dotted line on the graph.

Note: Invalid value errors occur when values are entered outside of system operating range (see [Appendix B](#)).

Note: Alarm limits are required for every parameter configured.

Manufacturer-Defined Default Alarm Limits

The manufacturer-defined default alarm limits have been determined to be medium priority based on the criteria described in [Appendix B](#).

The minimum and maximum values for each alarm limit can be modified. Specific cases may require adjustment of these limits from the manufacturer-defined alarm limits based on clinical judgment. The alarm priority does not change even if the alarm limits are changed. Significant deviation from the manufacturer-defined default limits may not be consistent with the priority alarm conditions listed in [Appendix B](#).

Note: Although values outside default ranges may be displayed, alarms limits can be set only within the maximum/minimum ranges listed in [Appendix B](#).

Note: The highest setting for the alarm volume is 74 dBA.

Note: No alarm is associated with Shunt Sensor temperature.



Warning

- ✦ **Ensure that all current preset alarm limits are appropriate prior to use in each case. Proceeding with inapplicable alarm limits may reduce the effectiveness of the alarm system.**
- ✦ **Alarm limits should not be set to extreme values, as this may reduce the effectiveness of the alarm system.**
- ✦ **Setting different alarm configurations for the same or similar equipment in any single area is potentially hazardous.**

Case Profile Configuration

Events (Optional)

The **Events Tab** allows configuration of events that can be marked during measurement.

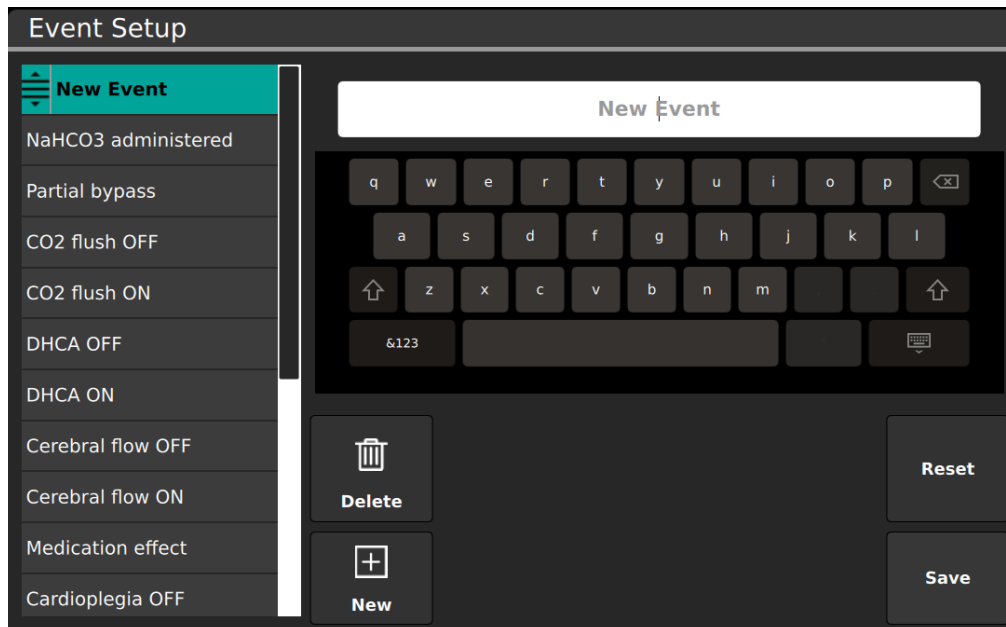

To create and delete event names and set the order in which they are listed:

- To create a new event, tap *New*, then type the new event name.
- To delete an event, select the event from the list and tap *Delete*.
- Items within the list can be rearranged. Press and hold an event for two seconds, then drag it to the desired position in the list.
- *Reset* reverts the event list back to the manufacturer default list.
- Once all changes have been made, tap *Save*.

Note: For normal users, changes will be saved for the current case only.

Case Profile Configuration

Multi-Graphs (Optional)

The CDI OneView System can display the patient's blood gas parameter values in graphical format. The purpose of Graph Layout Builder is to create optional, multi-parameter graphs. Up to four such multi-graphs can be configured to view simultaneously. Any parameter that has been configured on the Display Layout tab can be added to a graph, and each graph can include up to four parameters.

Note: Any parameter can be viewed as a single graph by tapping on that parameter tile on the Measurement Screen.

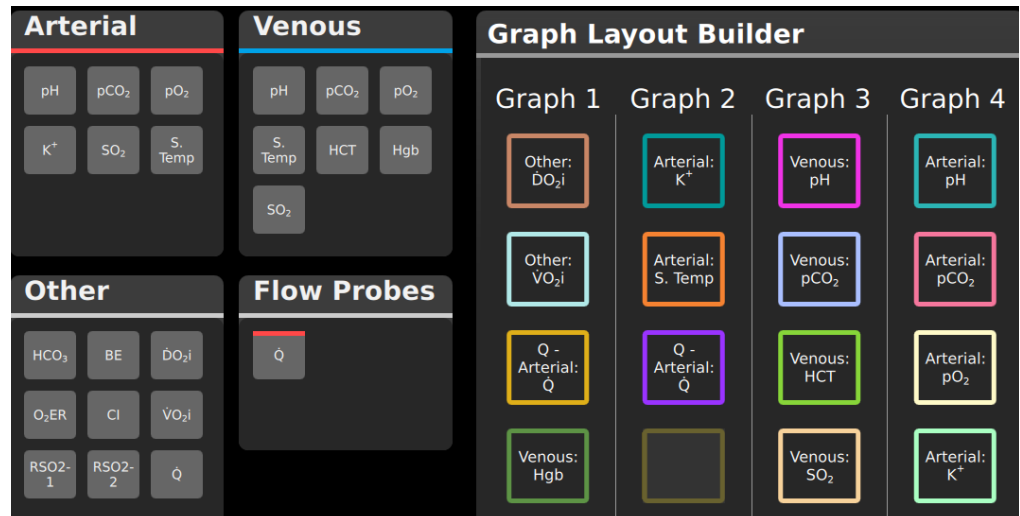

To create and edit multi-graphs:

1. To add a parameter to a graph, tap on the parameter tile. Once the parameter tile is selected, available cells are highlighted in the Graph Layout Builder. Tap one of the available cells to place the tile. The parameter is placed in the cell, and the parameter's outline color in the Graph Layout Builder reflects the color of its graph line when viewed in Measurement Mode.
2. To remove a parameter from a graph, tap on the parameter in the Graph Layout Builder.
3. Tap *Save* when all graphs are configured as desired.

Note: Any tile under any graph can be left empty.

Note: The same parameter can be added to multiple graphs.

Note: A single parameter cannot be added twice to the same graph.

Case Profile Configuration

Save Default Permanent / Temporary Toggle



Permanent: Changes to the case profile will be made permanently.



Temporary: Changes to the case profile will be saved for this case only, after which all changes will revert to case profile defaults.

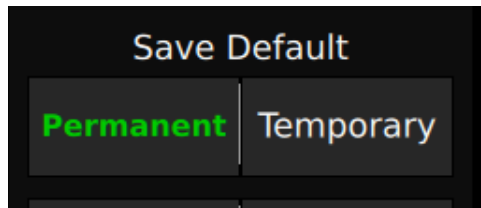

Dark/Light Toggle

Toggles the interface between dark and light mode.

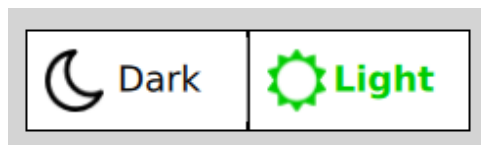
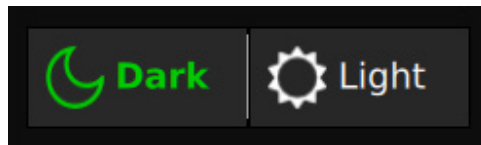

Calibration and Circuit Setup

Calibration

This section explains how to gas-calibrate Shunt Sensors prior to clinical use.

For the calibration procedure, you need the following:

- CDI OneView Touchscreen Display [CDI751]
- CDI OneView Processing Core [CDI750]
- CDI OneView Calibrator [CDI740] with Gas 1 and Gas 2 bottles installed
- CDI OneView BPM Probe(s) [CDI753]
- CDI Shunt Sensor(s) [CDI510H] to be calibrated (Arterial and/or Venous)

Before calibration, make sure the calibrator is set up as described in [Chapter 2, "Calibrator Setup."](#)

Note: A full two-point gas calibration procedure is necessary to achieve maximum measurement performance. In cases where the user cannot perform a full two-point gas calibration, the user should still input the K⁺ calibration code from the sensor pouch to ensure optimal K⁺ measurement performance.

Note: Gas calibration cannot be initiated while operating on backup battery power.



Warning

- ✦ **Failure to complete calibration as described in this section may result in compromised system performance that does not meet the System Accuracy Limits found in [Appendix B.](#)**

Calibrator Setup

1. Connect the right-angle end of the calibrator cable to the back of the Calibrator by aligning the notch and red dots, then pushing in the cable until it clicks.
2. Connect the other end of the Calibrator cable to the Calibrator port on the back of the Core by aligning the red dots and pushing in the cable until it clicks. See [Chapter 1, "Core"](#) for Calibrator port location.
3. Check the expiration dates on the labels of the gas bottles.
4. Remove the caps from the gas bottles.
5. Place the Gas 1 bottle into the yellow slot on the calibrator and twist clockwise until resistance is felt. Do not overtighten.
6. Place the Gas 2 bottle into the blue slot on the calibrator and twist clockwise until resistance is felt. Do not overtighten.

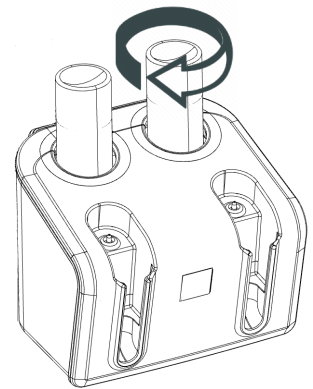

Calibration and Circuit Setup

Calibration Home

First select a case profile, then tap *Calibrate* from the Home Screen.

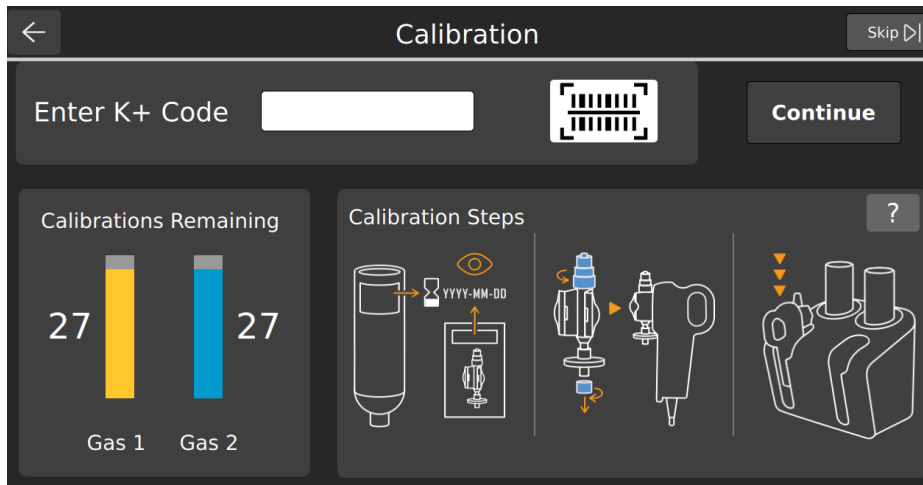

Note: Tap *Skip* at the top right of the calibration screen to skip calibration.

Prepare the BPM Assembly

1. Open the Shunt Sensor package, remove the sensor, and inspect for damage to the optical surface of the sensor body.



Caution

- Do not open the pouch until the sensor is to be used. Once the pouch is opened, the sensor must be used within 24 hours or inaccurate calibration may result.
- Do not use the sensor if the foil pouch has been damaged. Damage to the foil pouch can result in inaccurate calibration and/or measured parameter values.

2. Check that the sensor contains adequate buffer solution before calibration. To do this, hold the sensor assembly vertically and ensure the buffer solution completely covers all four microsensors.



Warning

- ✦ **Avoid touching the optical surfaces of the CDI Shunt Sensor. Fingerprints on these surfaces can reduce the accuracy of the system.**
- ✦ **Do not add or remove solution in the sensor assemblies. The composition and volume of the buffer solution has been preset during manufacturing for optimum calibration time and accuracy.**



Caution

- Do not use sensor assemblies that are not filled adequately with buffer solution. Sensor assemblies not filled with adequate buffer solution may not calibrate properly.
- Do not wipe moisture or particulates from the surface of the sensor assembly that connects to the BPM. Damage to this surface can result in inaccurate performance.

Calibration and Circuit Setup

- The K⁺ Code is a three-digit number and letter listed on the label of the Shunt Sensor's foil pouch. Tap the entry field on screen and input the K⁺ Code.



Optional: For Shunt Sensor packaging that includes a 2D barcode, the K Code can be entered by scanning using the camera under the Display. Tap the barcode icon and align the barcode under the Display until the barcode is captured and shown on screen.

- Ensure the K⁺ Code entered matches what is shown on the package.
- Verify Shunt Sensor expiration date(s).

Note: The barcode camera also verifies expiration dates.

- Remove BPM from the holder on the back of the Display.
- Attach the Shunt Sensor to the BPM by aligning it with the BPM optical head. Press firmly in the center of the Shunt Sensor (between the wings) until the Shunt Sensor snaps into place to create the BPM assembly.

Note: The sensor will snap securely onto the BPM and will fit only one way.

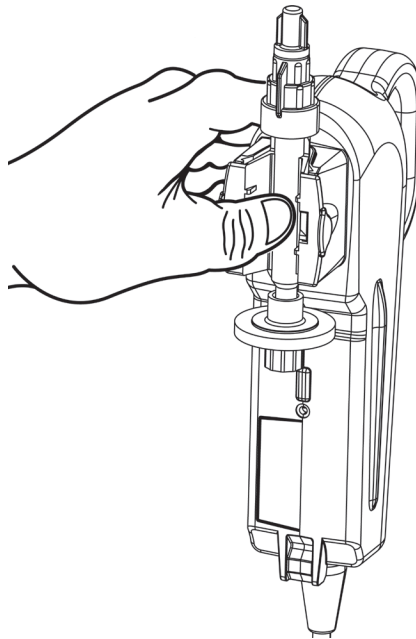

CALIBRATION INSTRUCTIONS CONTINUED ON NEXT PAGE:

Calibration and Circuit Setup



Warning

- ✦ **Using uncalibrated BPM assemblies may result in inaccurate values. A K⁺ Code is required to skip calibration. If calibration is skipped, the system will use the last K⁺ Code entered.**
- ✦ **Do not remove the sensor filter/sparger assembly from the CDI Shunt Sensors until ready to connect them to the circuit. The microsensors inside the CDI Shunt Sensors must be kept sterile and moist. Exposure to air for more than a few minutes can damage the microsensors.**

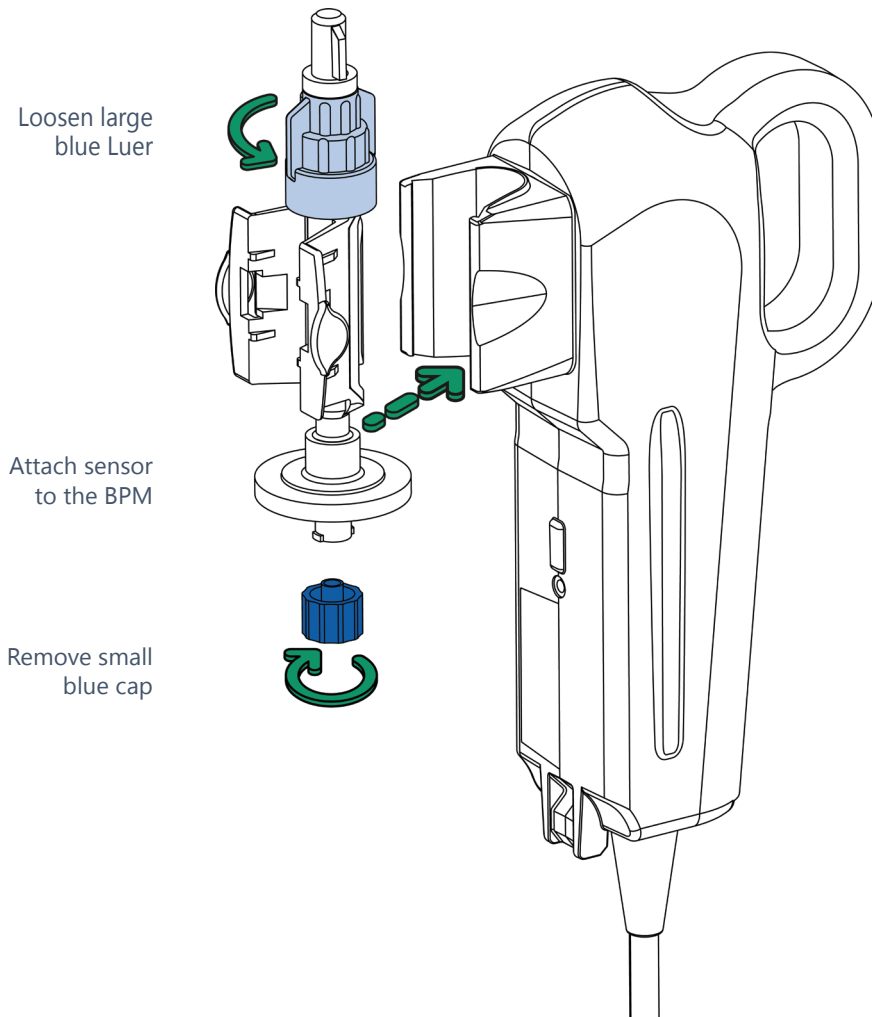

8. Remove the small blue cap from the filter/sparger assembly (see image above).
9. Using sterile technique, fully loosen the large, blue top-venting Luer on the sensor(s). The cap will stay attached to the top of the sensor, allowing venting of the buffer solution without compromising the sterility. The filter/sparger assembly will prevent the buffer solution from leaking out of the sensor.

CALIBRATION INSTRUCTIONS CONTINUED ON NEXT PAGE:

Calibration and Circuit Setup

Prepare to Calibrate

10. Place BPM assembly in either pocket of the Calibrator, pushing it down until it stops and locks into place. The BPM is connected properly if it can resist a gentle tug. This ensures a good connection between the sensor and Calibrator.

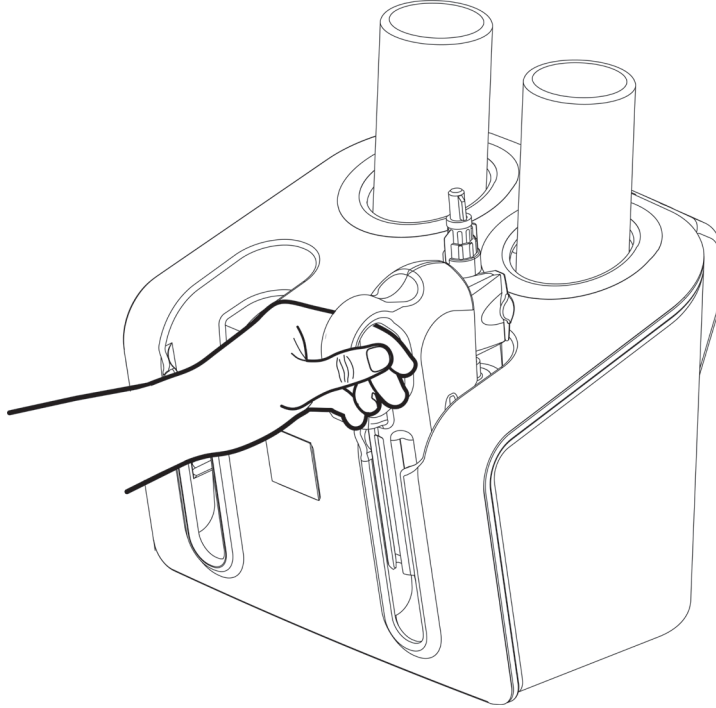

To calibrate a second sensor, repeat steps 1-10 for that sensor.

Note: If only one sensor is being calibrated, the Calibrator will automatically detect the port being used and shut off flow to the unused port.

11. Ensure the gas bottles are inserted in the Calibrator and that enough calibrations are remaining to continue. If there are not enough calibrations remaining, replace the gas bottles.

Note: The number of calibrations remaining approximates the number of individual sensor calibrations left. When calibrating both arterial and venous sensors, the count will decrease by two. A set of full gas bottles provides enough gas for roughly 30 individual sensor calibrations.

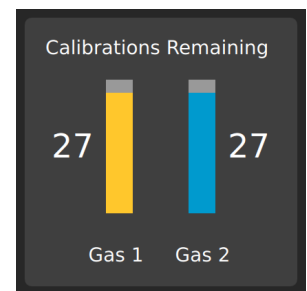

Note: If the gas in either bottle is insufficient to perform a calibration as indicated on the display, the calibration process cannot be initiated.

12. Check expiration dates on the gas bottles. If they have expired, replace them.

CALIBRATION INSTRUCTIONS CONTINUED ON NEXT PAGE:

Calibration and Circuit Setup

13. When all the previous steps have been completed, tap

Continue

Note: If the *Continue* button is not enabled, double-check the following:

- A valid K⁺ Code has been entered.
- The Calibrator cable is connected to the Core and to the Calibrator.
- The Gas Bottles are connected and have sufficient gas to perform a calibration.

14. When calibration is ready, the following window will appear and highlight the current number of BPM assemblies detected. Tap *Start Calibrating*.

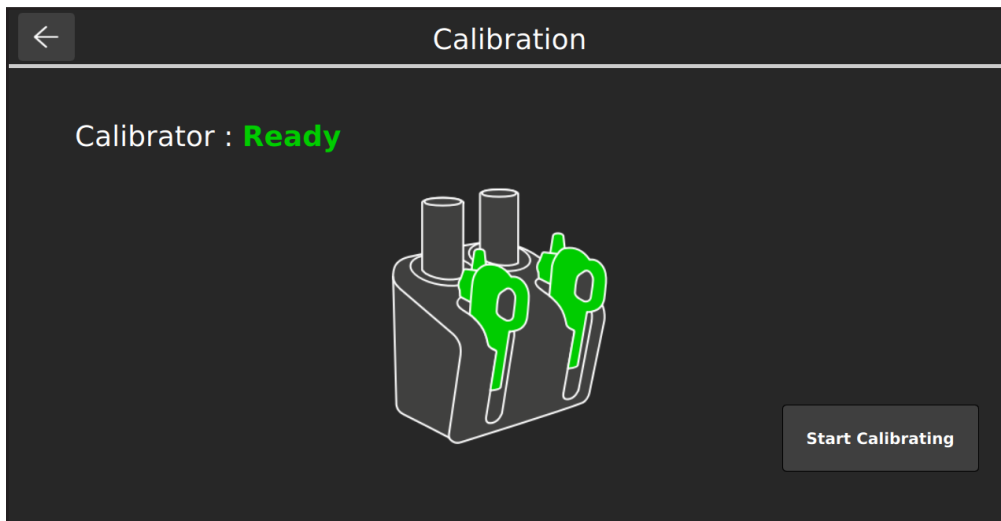

Note: Do not change the number of BPM assemblies in the calibrator while calibration is in process. Doing so will abort the calibration process.

CALIBRATION INSTRUCTIONS CONTINUED ON NEXT PAGE:

Calibration and Circuit Setup

Note: If the BPM assembly is not properly seated, the following window will appear. The Calibrator pockets will reflect the BPM assignments in the case profile.

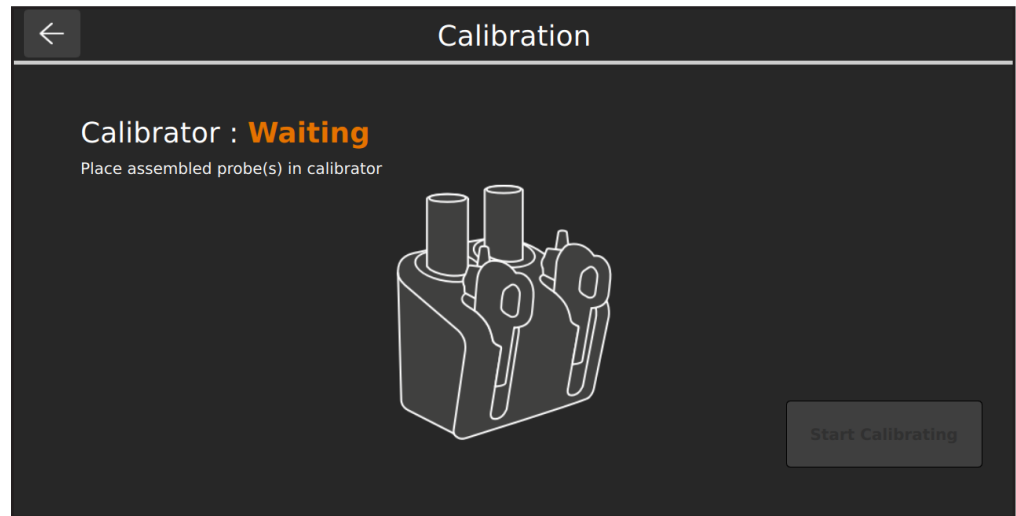

Note: When only one BPM needs to be calibrated again, the *Start Calibration* button can be tapped despite appearing inactive.

The following window appears during calibration, which takes approximately ten minutes. The *Stop Calibrating* button can be pressed anytime if necessary.

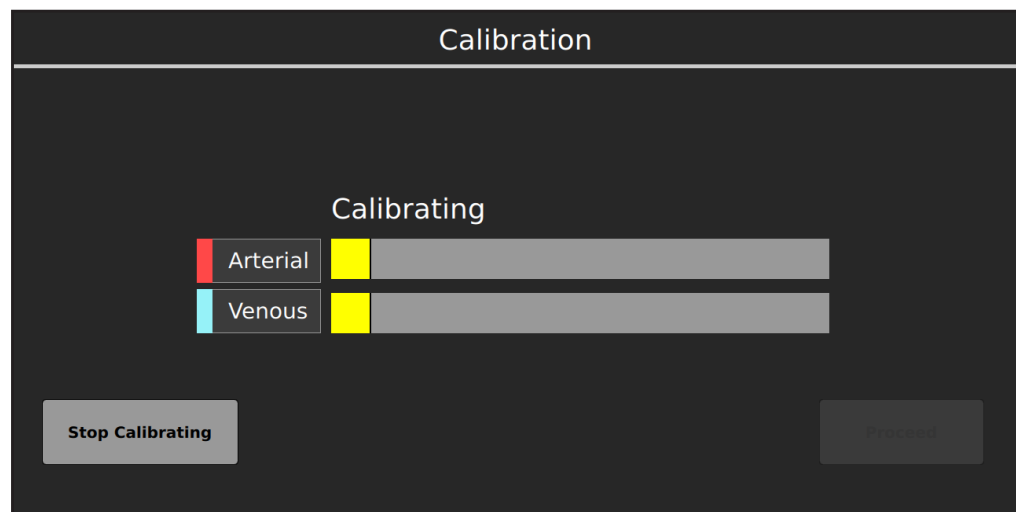

If any error messages appear, follow the instructions on the screen, or consult the [Gas Calibration table in Chapter 6 "Troubleshooting"](#) to resolve the problem.

Note: A small amount of calibration fluid may be initially displaced from the sensor through the top fitting. This loss of fluid is normal and does not affect accuracy.

Note: During calibration gas will audibly bubble through each sensor.

CALIBRATION INSTRUCTIONS CONTINUED ON NEXT PAGE:

Calibration and Circuit Setup

Conclude Calibration

After the calibration is successfully completed, the following window appears.

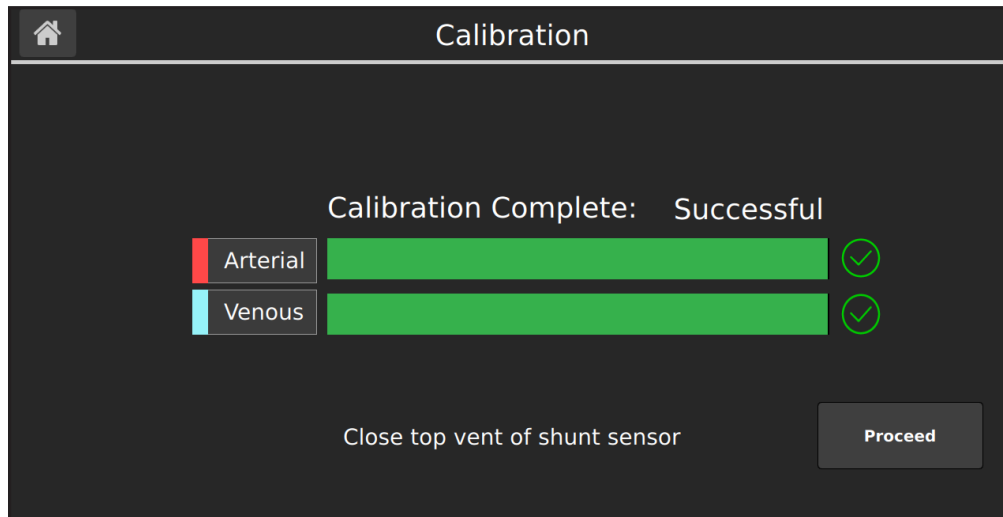

Follow the steps below to conclude calibration:

1. Verify that the calibration was successful by ensuring no error messages have appeared on screen and that a green checkmark is displayed next to both sensors.
2. **(Optional)** Disconnect the calibrator cable from the Calibrator.
3. Using sterile technique, close the top vent on the Shunt Sensor(s).
4. Tap **Proceed**.



Warning

- ✦ **Make sure the top vent of each Shunt Sensor is tightened securely to avoid leakage and maintain sterility.**

5. Remove the BPM assembly(s) from the calibrator. If you are not placing the sensor in-line within one hour of gas calibration, re-attach the bottom blue Luer cap to the filter/sparger assembly.



Caution

- *Do not use the cable connected to the BPM to pull the BPM assembly out of the calibrator. Pulling on the cable may result in wire damage.*

6. To place the BPM(s) on the BPM bracket(s), align the T-shaped slot of the BPM to the T-shaped bar of bracket plate and slide into place.

Notes: After calibration, as long as buffer solution level is above the top microsensor and all caps are tightly fastened, the sensors can be used for up to 24 hours.

Calibration and Circuit Setup

Sensors that have been calibrated successfully are ready for placement into the extracorporeal circuit. Continue to the next page for further instructions.

The CDI OneView System remembers the most recent calibration data, even when paused or switched off. The calibration data is replaced only when a new calibration is performed.



Warning

- ✦ **Do not empty calibration fluid from the sensor assembly, as microsensors must be kept wet. If the Shunt Sensor is left uncapped for more than a few minutes, dry-out may occur that will affect sensor performance.**

Calibration and Circuit Setup

Sensors and Cuvettes

This section explains how to place the CDI Shunt Sensors and H/S Cuvette into the extracorporeal circuit and how to attach Flow Sensors.

Prepare Disposables to Install

To install Shunt Sensors, the following is required:

- CDI Shunt Sensor(s)
- CDI H/S Cuvette
- Access to the bypass circuit

For additional information, refer to disposable instructions for use.

Note: CDI Shunt Sensors and H/S Cuvettes can be used for either Arterial or Venous application.



Warning

- ✦ **Once calibrated, do not remove and replace the sensor from the BPM prior to use. Removal and replacement could affect the measurement accuracy of the system.**



Caution

- *Care should be taken to prevent BPMs from dropping onto any hard surface or otherwise receiving severe shock. If a drop occurs, the BPM should be carefully inspected for any damage to the silver-domed thermistor contact, the optical pathways, or the BPM housing surfaces. If the BPM had a sensor installed and calibrated, you should replace the sensor and repeat the calibration.*

Calibration and Circuit Setup

Install the Shunt Bypass Line and CDI H/S Cuvette

If the Shunt Bypass Line and CDI H/S Cuvette are supplied in a single sterile package, remove them from the package and aseptically insert them into the extracorporeal circuit. If they are supplied as part of a tubing pack, this installation is not necessary.



Warning

- ✦ **Aseptic technique must be used when inserting the CDI H/S Cuvette and Shunt Bypass Line into the extracorporeal circuit to ensure that the blood-contacting surfaces remain sterile.**
- ✦ **Use an arterial filter distal to the Shunt Bypass Line on the arterial side of the circuit. This protects against introduction of air into the blood circulation.**
- ✦ **The presence of air bubbles on the optical window of the CDI H/S Cuvette can result in reduced measurement accuracy. Intermittent bubbles, once moved from the optical window, will not affect the long-term accuracy of the system.**
- ✦ **Avoid touching the optical surfaces of the CDI H/S Cuvette and the optical CDI H/S Probe. Fingerprints on these surfaces can reduce the accuracy of the system. If necessary, optical surfaces on the CDI H/S Cuvette and CDI H/S Probe can be cleaned with a soft, lint free cloth.**



Caution

- *Secure the Shunt Bypass Line tubing connection with tie-bands.*
- *The CDI Shunt Sensor can only be connected to the Shunt Bypass Line in one direction. The Shunt Bypass Line must be oriented in the bypass circuit to the desired placement of the BPM and cable direction.*
- *The Shunt Bypass Line must have the CDI Shunt Sensor side down in the circuit, to prevent air trapping in the CDI Shunt Sensor.*
- *The CDI H/S Cuvette contains an optical window that provides a means of consistent optical connection between the optical CDI H/S Probe and the CDI H/S Cuvette. Insert the CDI H/S Cuvette face down into the circuit, so that the CDI H/S Probe, when attached, will be on the lower side of the CDI H/S Cuvette. This minimizes interference from intermittent air bubbles in the line.*
- *End caps are provided (on the single sterile assemblies) at each end of the Shunt Bypass Line and the CDI H/S Cuvette to protect the blood pathways from contamination prior to insertion into the tubing. The Shunt Bypass Line and CDI H/S Cuvette remain sterile if the package is unopened and undamaged.*

Calibration and Circuit Setup

Install a CDI Shunt Sensor

The heparin-coated, sterile CDI Shunt Sensors, Model CDI510H, are intended for placement into shunt lines, purge lines, sampling lines, Shunt Bypass Lines or any similar line that has constant blood flow.



Warning

- ✦ **The CDI Shunt Sensor is supplied sterile. Aseptic technique must be used when inserting it into the extracorporeal circuit to ensure that the blood-contacting surfaces remain sterile.**
- ✦ **Avoid touching the optical surfaces of the BPM and Shunt Sensor(s). Fingerprints on these surfaces can reduce the accuracy of the system.**



Caution

- *Place the CDI Shunt Sensor distal to a purge line one-way valve to avoid possible back-flow of air.*
- *Connecting the unsupported CDI Shunt Sensor directly to another rigid plastic piece may make the unsupported piece or the CDI Shunt Sensor susceptible to breakage.*
- *When connecting the CDI Shunt Sensor to another rigid plastic piece such as a manifold, either provide extra support for the Shunt Sensor, or use a length of pliable tubing to connect to a bracket-supported Shunt Sensor.*

Note: The CDI Shunt Sensor can be placed in the shunt/purge line at any time during priming or bypass if there is fluid in the circuit. The flow of fluid must be stopped prior to inserting the sensor to avoid loss of fluid.

Note: The sensor is bidirectional. Blood can flow through it in either direction.

Note: When placing the CDI Shunt Sensor in a sampling line, place it on the inlet side of the sample port to avoid intermittent interruption of blood parameter data during medication administration.

Note: The end of the CDI Shunt Sensor that has the large blue Luer cap is known as a male Luer connector. The end of the CDI Shunt Sensor attached to the filter/sparger assembly is a female Luer connector.

Calibration and Circuit Setup

Follow these steps to install the CDI Shunt Sensor into a shunt/purge line:

1. Ensure the positioning of the BPM and CDI Shunt Sensor is convenient for connection into the shunt/purge line.
2. Using sterile technique, remove the top Luer cap (white) from the CDI Shunt Sensor and attach one end of the "shunt/purge" line to the top of the CDI Shunt Sensor. Make sure the large blue top venting luer is completely tightened.

Note: The sensor remains attached to the BPM while being installed in the circuit.

3. Remove the sensor filter/sparger assembly from the bottom of the sensor. Attach the other end of the shunt or purge line to the sensor.

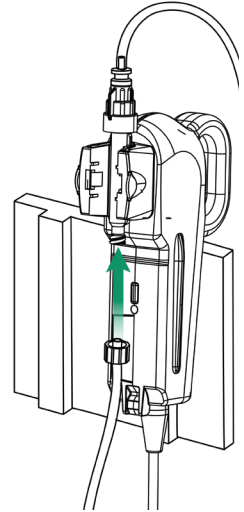

Note: Air bubbles may clear more easily from the CDI Shunt Sensor when it is in an upright position. Intermittent bubbles, once removed from the CDI Shunt Sensor, will not affect its long-term accuracy.

4. Prime and debubble the shunt/purge line, inspecting the line and CDI Shunt Sensor for bubbles.
5. Clear excess cabling from the work area.



Warning

- ✦ **Prime solutions containing acetate ions such as Isolyte-S, Normosol-R, or Plasma-Lyte A can cause damage to the pCO₂ sensor. If the pH channel reads less than 7.00 after the sensor is placed in the circuit, you should either recirculate the prime solution using a CO₂-free sweep gas or add sufficient buffer to raise the pH of the prime above 7.00. Exposure to acetate-containing prime solutions below pH 7.00 for longer than a few minutes can cause significant pCO₂ inaccuracy.**
- ✦ **Exposure of the Shunt Sensor to prime solutions and/or blood with pH less than 7.0 or greater than 7.8 pH units can interfere in the accurate measurement of potassium.**
- ✦ **Exposure of the Shunt Sensor to prime solutions and/or blood with sodium measurement less than 120 or greater than 160 mEq/L can interfere in the accurate measurement of potassium.**
- ✦ **The presence of air bubbles in CDI Shunt Sensors can affect the results. Intermittent bubbles, once removed from the CDI Shunt Sensor, will not affect its long-term accuracy.**
- ✦ **Make sure all Luer lock connections are securely tightened before priming the shunt/purge line. Unsecured connections can result in a leak.**

Calibration and Circuit Setup

Install a CDI Shunt Sensor into the Shunt Bypass Line



Warning

- ✦ **Do not allow the CDI Shunt Sensor to dry out. Make sure the circuit has prime fluid in it before attaching the Shunt Sensor. Exposure to air for more than a few minutes can damage the sensor and cause inaccurate results.**



Caution

- *Do not remove the CDI Shunt Sensor from the BPM to make sensor connections.*

1. Stop the pump and/or clamp off the Shunt Bypass Line.
2. Using sterile technique, remove the blue cap from the female Luer end of the Shunt Bypass Line and the small top Luer cap (white) from the top of the CDI Shunt Sensor.
3. Attach the CDI Shunt Sensor to the female Luer end of the Bypass Shunt Line.
4. Using sterile technique, remove the white cap from the male rotating Luer connector on the Shunt Bypass Line.
5. Remove the filter/sparger assembly (clear) from the CDI Shunt Sensor.
6. Attach the male rotating Luer end of the Shunt Bypass Line onto the CDI Shunt Sensor.

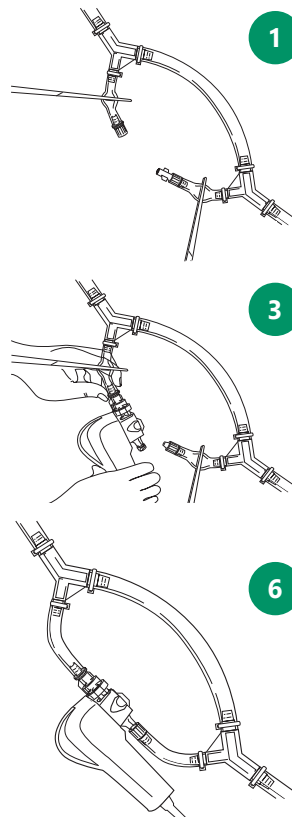

Note: Blood flow can go either direction through the Shunt Sensor, but the sensor will fit onto the Shunt Bypass Line only one way.

7. Unclamp the Shunt Bypass Lines and start the pump to circulate prime solution with a pH of 7.0-7.8 through the Shunt Sensor.
8. Prime and debubble CDI Shunt Sensor and the Shunt Bypass Line, inspecting the line and CDI Shunt Sensor for bubbles.
9. Verify that the BPM is sufficiently supported and that the tubing is not kinked.

Note: If the Shunt Bypass Line has been placed in the bypass circuit and the CDI Shunt Sensor is not going to be used, one of the following steps should be taken:

- Remove the Shunt Bypass Line from the circuit, or
- Connect the short legs of the Shunt Bypass Line together (female Luer connector to male rotating Luer connector)

Calibration and Circuit Setup

Attach the CDI H/S Probe for Hematocrit/Saturation Measurement

Follow the steps below to attach the CDI H/S Probe to the CDI H/S Cuvette for HCT, Hgb and SO₂ measurement.

1. Verify expiration date of the H/S Cuvette.
2. Remove the H/S Probe from the probe holder by pressing down on the release lever on top of the probe.
3. Clip the probe to the H/S Cuvette by inserting the tab on the cable end of the probe into the receptacle on the CDI H/S Cuvette.
4. Press the H/S Probe and H/S Cuvette together until the release lever is latched and a click is heard.

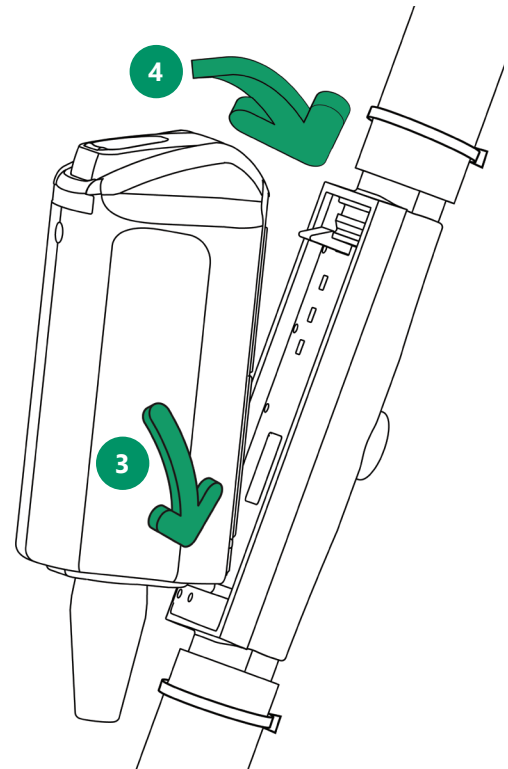

Warning

- ✦ **Avoid touching the optical surfaces of the CDI H/S Cuvette and the CDI H/S Probe. Fingerprints on these surfaces can reduce the accuracy of the system. If necessary, optical surfaces on the CDI H/S Cuvette and CDI H/S Probe can be cleaned with a soft, lint free cloth.**



Caution

- *Although the CDI H/S Probe can be connected to the CDI H/S Cuvette any time after passing the self-check, the numbers reported will be invalid until blood enters the CDI H/S Cuvette.*

Calibration and Circuit Setup

Attach Flow Sensor

Follow the steps below to attach a Flow Sensor.

1. Open the Flow Sensor latch.
2. Seat the tubing in the sensor. Ensure the arrow on the sensor points in the direction of the circuit flow.
3. Close the sensor latch and ensure it is securely sealed.

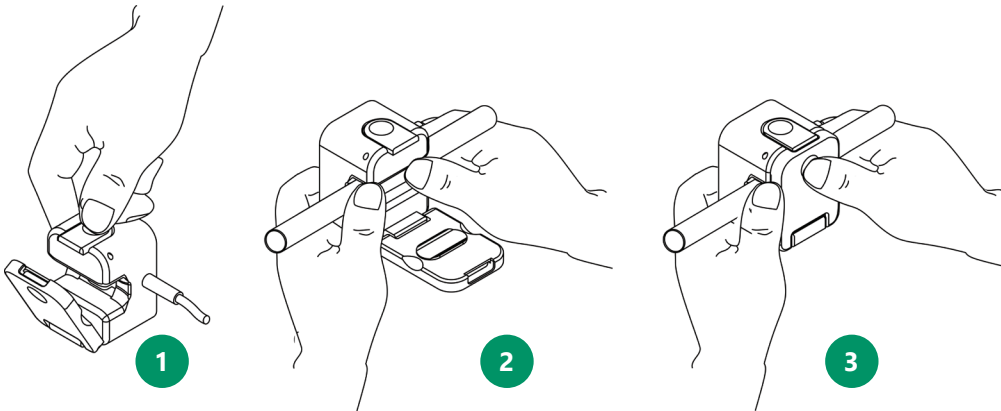

4. Wrap a color-coded identifier around the Flow Sensor cable.

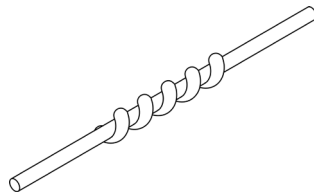

Note: Flow Sensors do not need to be calibrated.



Caution

- For best accuracy, position the 1/4" Flow Sensor at least 3 inches from any component in or attached to the extracorporeal circuit.
- For best accuracy, position the 3/8" Flow Sensor at least 4 inches from any component in or attached to the extracorporeal circuit.

Running a Case

This section provides instructions on how to observe and record patient data while in the Measurement Mode of the CDI OneView System.

Initiate Measurement Mode

While in Measurement Mode, the CDI OneView System continuously measures blood parameters.

Measurement Mode will always start in Pause Mode, whether by tapping Measure on the Home Screen or following a successful calibration. Pause Mode is shown below with the Play/Pause button outlined in green:

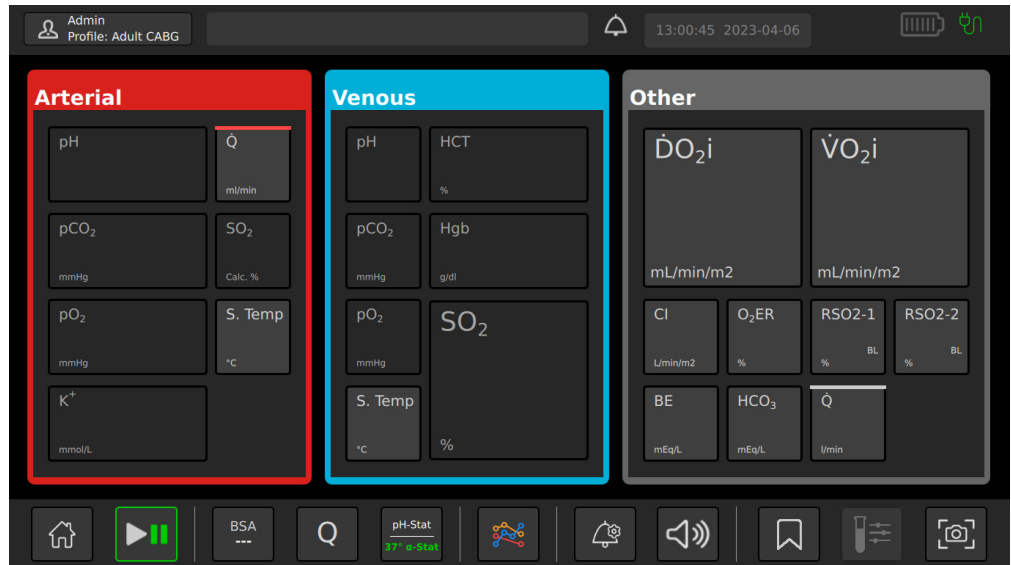

To start measuring, tap the Play/Pause button. Values will be displayed in the parameter tiles once measurement is initiated, as shown below:

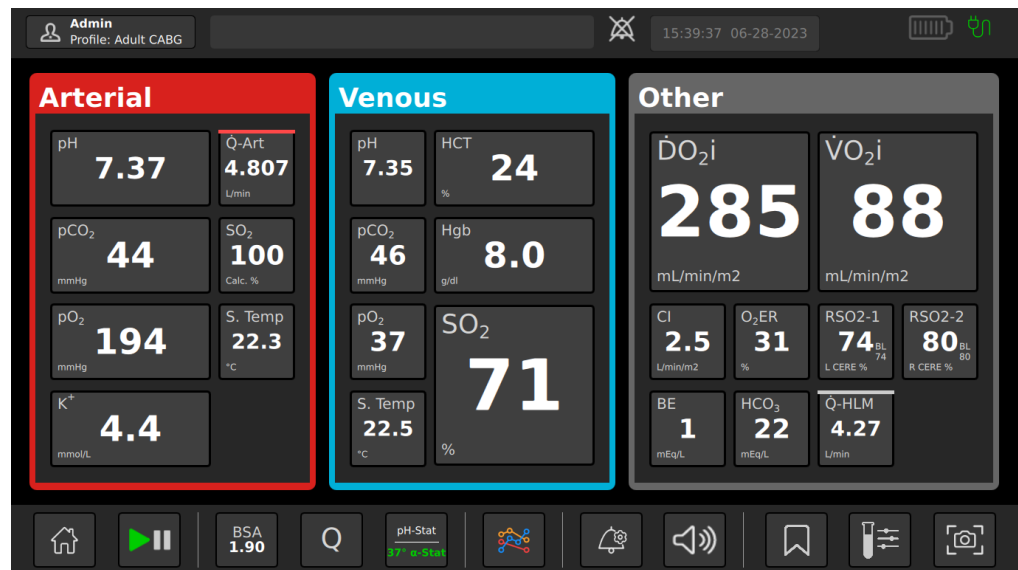

Note: Dashes appear for values that are out of the display range (listed in [Appendix B](#)) and for negative flow ranges from CDI Flow Sensors.

Running a Case

If a value is outside an alert limit specified on the Alerts/Alarms tab, a static white border appears with an arrow to indicate if the alert is high or low.

If a value is outside a medium-priority alarm limit specified on the Alerts/Alarms tab, a flashing yellow border appears with an arrow to indicate if the alarm is high or low, and an alarm sounds at the volume specified in Volume Settings.

When an rSO₂ alarm is triggered from the source device, the Display will signal the alarm status with a static white border and an arrow to indicate if the alarm is high or low.



Warning

- ✦ **Measured values prior to initial in vivo recalibration may not be accurate. Do not use values prior to initial in vivo recalibration for patient management.**

Note: When an alarm is triggered, audible and visual feedback occur. If the audible alarm is dismissed and a second alarm is triggered, both the audible and visual feedback will resume. Visual alarms indicating specific alarm conditions are perceptible at a distance of one meter from the front of the CDI OneView Display. No other intended position of the user with respect to the alarm signals is defined.



Warning

- ✦ **Use of Halothane anesthetic will result in significant pO₂ inaccuracy.**
- ✦ **Prime solutions containing acetate ions such as Isolyte-S, Normosol-R, or Plasma-Lyte A can cause damage to the pCO₂ sensor. If the pH channel reads less than 7.0 pH units after the sensor is placed in the circuit, you should either recirculate the prime solution using a CO₂-free sweep gas or add sufficient buffer to raise the pH of the prime above 7.0.**
- ✦ **Exposure to acetate-containing prime solutions below 7.0 pH units for longer than a few minutes can cause significant pCO₂ inaccuracy.**
- ✦ **Exposure of the Shunt Sensor to prime solutions and/or blood with pH less than 7.0 or greater than 7.8 pH units can interfere in the accurate measurement of potassium.**
- ✦ **Exposure of the Shunt Sensor to prime solutions and/or blood with sodium measurement less than 120 or greater than 160 mEq/L can interfere in the accurate measurement of potassium.**

Note: If the system shuts off completely during measurement, this will result in the loss of temporary case profile settings, patient BSA and any adjustments made to values during in vivo recalibration. In this case, re-enter the Patient BSA (if used) after switching the power back on and perform another in vivo recalibration. If the system is not switched off but the power is interrupted, the backup battery takes over (if charged), and these settings will not be lost.

Running a Case

Single-Parameter Graphs

Any parameter displayed in Measurement Mode can be tapped to view a graph of that parameter. This graph includes all marked events.

- The current parameter's value and alert/alarm limits are shown on the right. All active alerts/alarms are shown on the left.
- Tap the top of the graph to toggle between time ranges of 20 minutes, 2 hours and 6 hours of data for that parameter.
- Press, hold and drag anywhere on the graph to view previous data.
- The upper right shows either the time offset (in minutes : seconds) or *Live* highlighted in green. If the graph is displaying current data for the parameter, then *Live* will be highlighted in green. If the graph is at an offset, *Live* can be tapped to return to displaying current data.

See image below for an example of a single-parameter graph set to a time range of 20 minutes displaying live data:

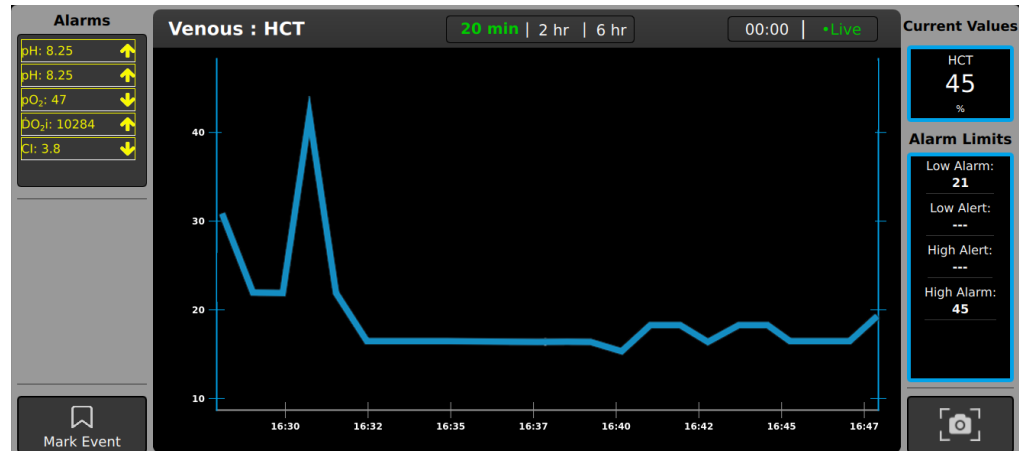

Running a Case

Measurement Mode Taskbar

The Measurement Mode Taskbar provides a variety of functions. The following section will look at each function of the taskbar in greater detail.



1. Home
2. Measurement/Pause Toggle
3. BSA
4. Flow Source for Calculation
5. Temperature Mode Toggle
6. Multi-Graph
7. Alarm Settings
8. Volume
9. Events
10. Store/Recall
11. Screenshot

Home



Tap the Home button to return to the Home Screen.

Note: To end a case, tap the Home button. A window will appear giving the option to end the case.

Play/Pause



Play

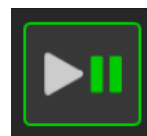

Pause

Tap the Play/Pause button to initiate Measurement Mode or to go into Pause Mode.

Note: Data is not captured while in Pause Mode, but Pause Mode does not end a case. A case can only be ended by tapping the *Home* button.

Running a Case

BSA

Tap the BSA button and use the number pad to enter the patient BSA.

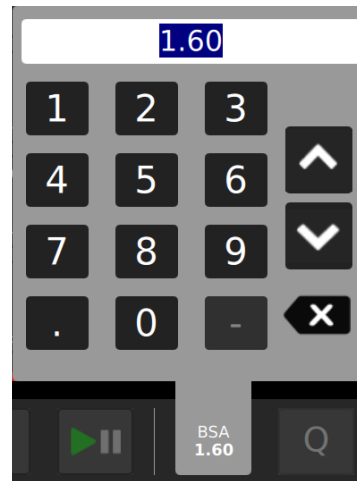

Flow Source for Calculation

Tap the Flow button to choose the Flow Source for Calculation of oxygen consumption and oxygen delivery.

The Flow Source options are to choose one of the four connected Flow Sensors, retrieve flow information from an external source or enter a manual flow using the number pad. Only previously configured devices will be available for selection.

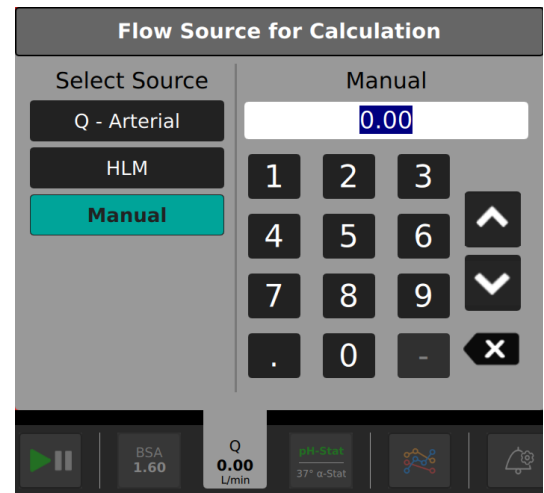
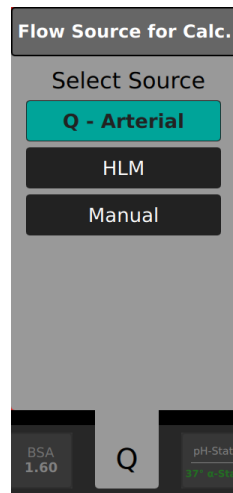

Note: The user will need either one BPM and one H/S Probe or two BPMs to get enough data to calculate VO_2 . This assumes the H/S Probe is placed on the venous side. If only an H/S Probe and a venous BPM Probe are used, the arterial oxygen saturation value will be assumed. This value is configurable in the **Data Options Tab** (see [Chapter 3, "Data Options"](#)).

Note: The user will need at a minimum one arterial BPM Probe and either a venous BPM or H/S Probe to get enough data to calculate DO_2 .

Running a Case

Temperature pH/ α -Stat Selection

Tap the pH-stat/37° α -stat button to display arterial and venous blood gas values either at pH-stat (actual temperature/measured) or corrected to 37°C alpha-stat. Toggle the pH-stat/37° α -stat to change the patient temperature mode.

Note: The temperature measured by a CDI Shunt Sensor will be that of the shunt / purge line, which may differ slightly from the temperature in the rest of the circuit because of the exposure of the shunt line to room air temperatures.

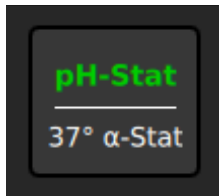

pH-Stat

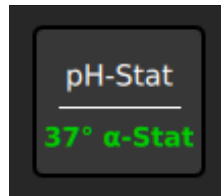

37° α -stat



Caution

- *Shunt Sensor temperatures do not reflect a patient's temperature and should not be used for patient temperature management.*

Running a Case

Multi-Graphs (Optional)

Tap the Multi-Graph menu to view preconfigured, multi-parameter graphs. Up to four multi-graphs can be arranged to view simultaneously.

- Multi-graphs can be shown as either Stacked or Overlay graphs. See the images below for examples.
- Toggle through the user-defined graph views by tapping the arrows on the left.
- The current parameters' values are shown on the right. All active alerts/alarms are shown on the left.
- Tap the top of the graph to toggle between time ranges of 20 minutes, 2 hours, and 6 hours of data for that parameter.
- Press, hold and drag anywhere on the graph to view previous data.
- The upper right shows either the time offset (in minutes : seconds) or *Live* highlighted in green. If the graph is displaying current data for the parameter, then *Live* will be highlighted in green. If the graph is at an offset, *Live* can be tapped to return to displaying current data.

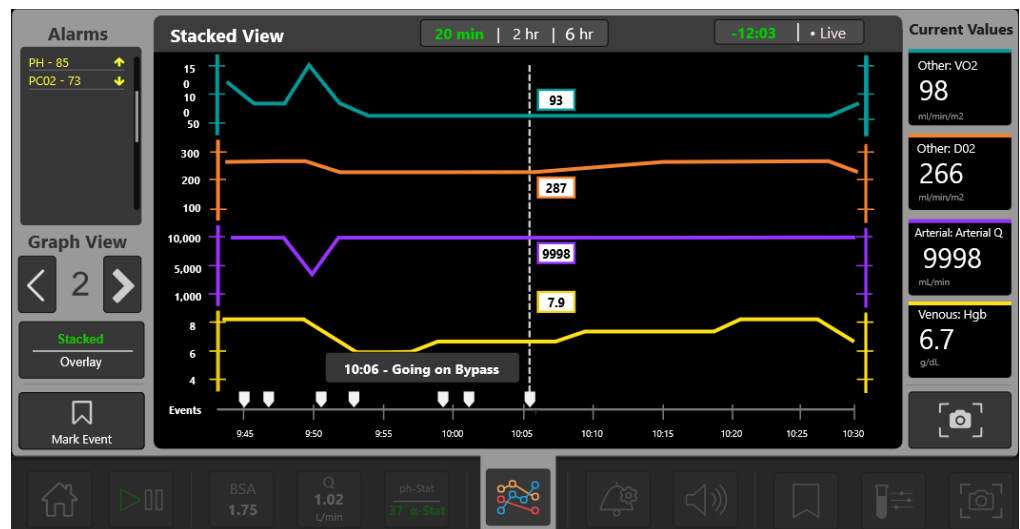

Stacked View



Overlay View

Running a Case

Alerts/Alarms

To set alert and alarm thresholds:

1. Tap the Alerts/Alarms button.
2. Tap the cell to edit that value.
3. Enter value with the number pad or use arrows to increase/decrease the value.
4. Tap outside the number pad to accept the value.
5. Once all changes are made, tap *Save*.

Reset to System Defaults – Resets all alarm limits to the manufacturer-defined default limits (refer to [Appendix B](#)). The manufacturer-defined default limits are derived from typical clinical values that can occur during CPB for which user intervention may be required.

Reset to Profile Defaults – Resets all alert and alarm settings to case profile defaults set by the admin.

Note: Set the low alarm limit at the desired threshold for DO₂ AUC calculation. The threshold will appear as a dotted line on the graph.

The screenshot shows the 'Set Alarm Thresholds' screen. At the top, there is a title bar with a question mark icon. Below the title bar is a horizontal bar with a color gradient (red, yellow, green, yellow, red) and a double-headed arrow. The main content is a table with the following data:

	Low Alarm	Low Alert	High Alert	High Alarm
pH	7.00	---	---	7.65
pCO ₂	35	---	---	60
pO ₂	30	---	---	65
Q̇	50	---	---	2500
pH	7.10	---	---	7.65
pCO ₂	30	---	---	55
pO ₂	85	---	---	500

On the right side of the screen, there are three buttons: 'Reset to System Defaults', 'Reset to Profile Defaults', and 'Save'.

Running a Case

Volume Settings

Tap the volume button to adjust the alarm volume setting.

- Tap the + or – icons or the slider to raise or lower the volume. The system will generate an example sound to demonstrate the current volume level.
- Tap *Pause* to pause an alarm until another alarm is triggered.
- Tap *Mute All* to mute all alarms.

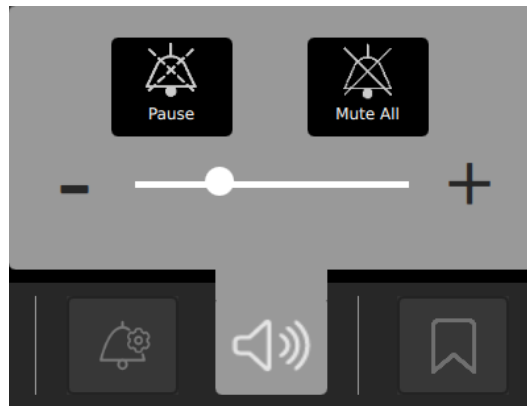

Events Menu

Tap the Events Menu to mark an event.

- To add a new event, tap **+** *New Event Label*.
- To use an existing event, scroll through the events list and select the desired event.
- Tap *Current* to mark a current event. To mark an event in the past, tap *Past* and enter the event time using the number pad.

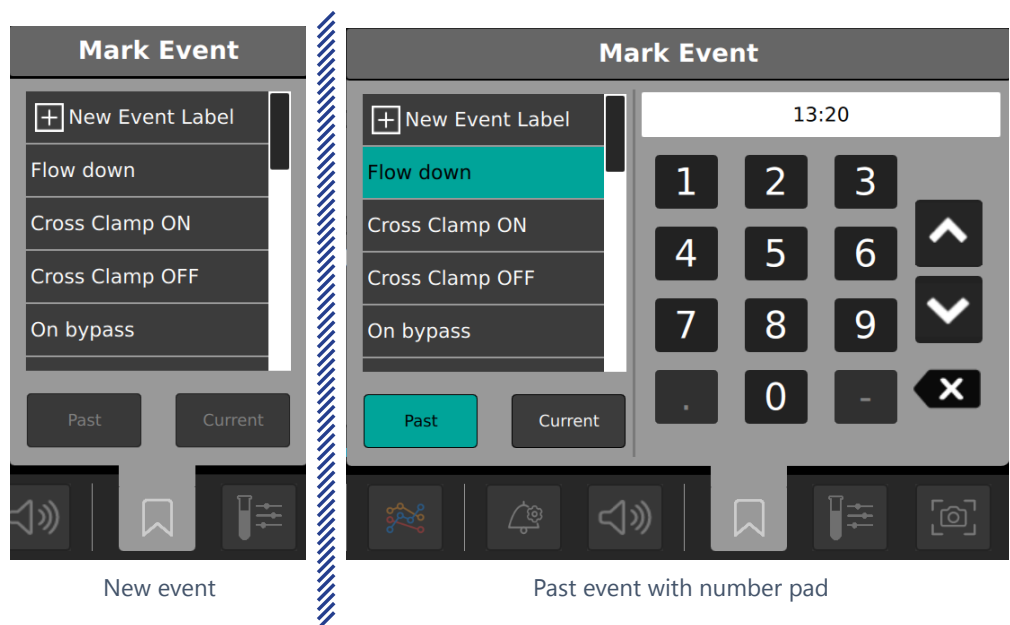

Running a Case

In Vivo Recalibration

An initial in vivo recalibration must be performed when starting a new case to ensure maximum correlation to laboratory-derived blood measurements. Recalibrate the system periodically during in-line operation if it is necessary for the system to correlate closer to the institution's laboratory-measured blood parameter values. (Institutions will dictate allowable variance between these two sets of measurements).

Note: *In vivo recalibration* should not be confused with *gas calibration*, which is a separate preliminary step also required for proper usage of the CDI OneView System. Steps to perform a gas calibration are detailed in [Chapter 4, "Calibration."](#)



Warning

- ✦ **Measured values prior to initial in vivo recalibration may not be accurate.**
- ✦ **Do not use values prior to initial in vivo recalibration for patient management.**



Caution

- *Both Arterial and Venous in vivo recalibrations are required to achieve maximum device accuracy.*

To perform in vivo recalibration of all measurable blood parameters, follow these steps:

1. Once the blood parameter values on the display have stabilized, tap the *Store/Recall* button, then *Store*. The *Store/Recall* button will turn green to indicate the system is ready for recalibration.
2. Immediately draw a blood sample from a sampling port close to the Shunt Sensor.
3. Send the sample for a laboratory measurement of all blood parameters.

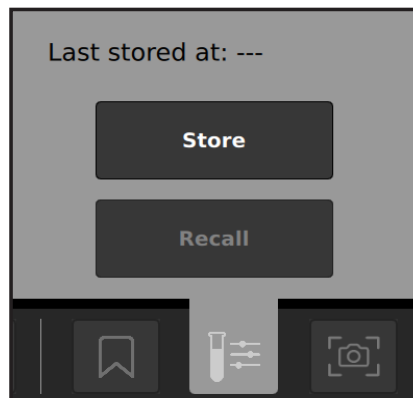

IN VIVO RECALIBRATION INSTRUCTIONS CONTINUED ON NEXT PAGE:

Running a Case



Caution

- For the best comparison with your laboratory, press the store key only after the circuit has been stabilized for approximately five minutes (when there have been no changes in temperature, fraction of inspired oxygen in a gas mixture (FiO₂), gas or blood flows, other parameters or addition of medications that would cause changes in displayed values). If the store button is pressed and/or the recalibration blood sample is drawn during periods of significant temperature or gas change, the system may not meet the system accuracy limits found in [Appendix B](#).
- Draw the blood sample as close as possible to when the store button is pressed to ensure the blood parameter values are calibrated as accurately as possible.
- Ensure that the stored and recalled temperature mode are the same as the laboratory sample to ensure proper calibration. Recalibrating to different temperature modes will compromise the system accuracy limits, as described in [Appendix B](#).

Note: If the laboratory blood gas values are 37°C, the system must be in a-stat mode. If the laboratory gas values are at patient temperature, the monitor must be in actual (pH-stat) mode. The stored temperature mode can be switched in the recalibration screen, however the temperature value used in the actual temperature mode cannot be adjusted.

4. When the lab values are received, tap *Recall*. The In Vivo Recalibration screen opens, as shown below.

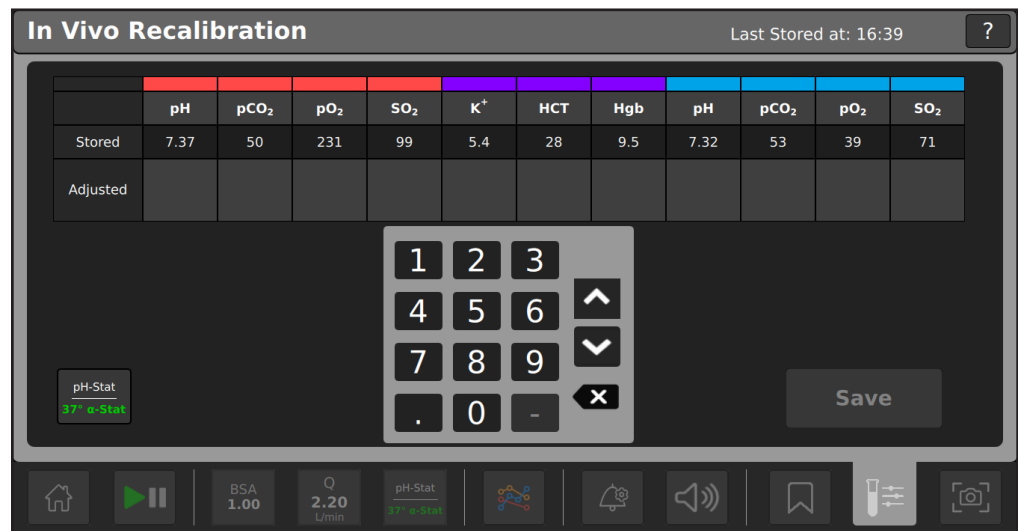

IN VIVO RECALIBRATION INSTRUCTIONS CONTINUED ON NEXT PAGE:

Running a Case

5. Enter a laboratory value into the adjusted cell by tapping the desired cell. The cell will auto-fill with the stored value. The value can be adjusted with the number pad. Tap outside the flyout to cancel, or delete the number on the number pad.
6. Once the adjusted value(s) has been entered, tap *Save*.

Note: At least one value must be entered to recalibrate, but not all values are required to be recalibrated.



Warning

- + **Measured values prior to initial in vivo recalibration may not be accurate. Do not use values prior to initial in vivo recalibration for patient management. Failure to perform a proper setup, full two-point tonometered gas calibration and initial in vivo recalibration may result in compromised system performance that does not meet system accuracy limits found in [Appendix B](#).**

Note: If VO_2 and DO_2 are desired when using 2 BPMs (only), the user must supply a hematocrit value. A set value for hematocrit will be displayed and is adjustable while in Measurement Mode. In this module configuration, both arterial and venous oxygen saturations are calculated, and the hematocrit is entered by the user. Blood flow data is obtained in the same way described above.

After an in vivo recalibration has been performed on a parameter, the parameter value becomes bold and its tile becomes lighter.

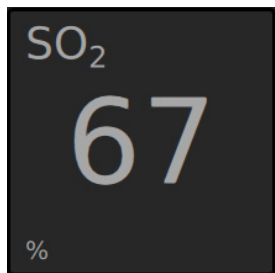

Pre-recalibration tile
(Dark Mode)

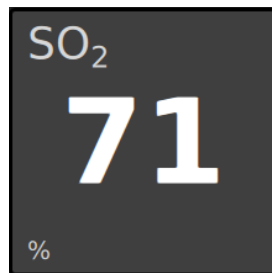

Post-recalibration tile
(Dark Mode)

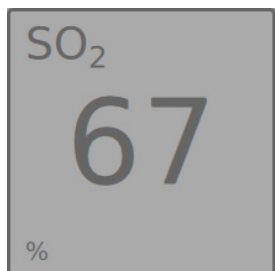

Pre-recalibration tile
(Light Mode)

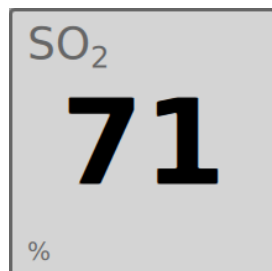

Post-recalibration tile
(Light Mode)

Running a Case

Screenshot

Tap the Screenshot button to capture and save a copy of the currently displayed screen.

- If a screenshot capture fails, a pop-up message will show *Screenshot failed*.
- A checkmark highlighted in green appears if a screenshot capture is successful.



Screenshot failed



Screenshot successful

All screenshots can be downloaded to a USB drive through the **Data Export Tab**.

Module Replacement

A BPM, H/S Probe or module can be replaced during a case.

1. Unplug the corresponding probe or module from the Core.
2. Plug in the replacement probe or module.
3. Confirm successful connection using the Message Center.

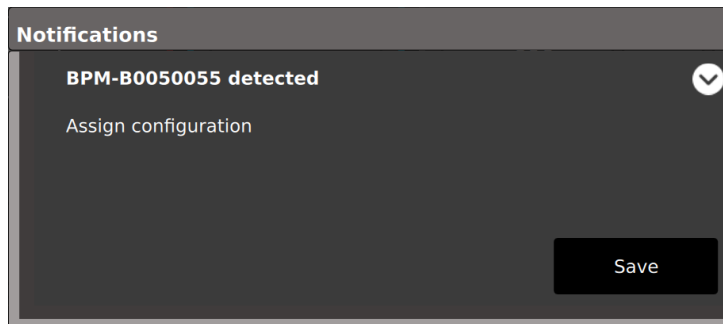

Note: A replacement H/S Probe will need to be docked on the H/S Probe holder to perform its color chip test.

Note: It will take the system time to detect and perform diagnostics for the newly connected probe or module.

4. Once detected, the system will resume measurement for associated parameters.

Touchscreen Deactivation

The touchscreen can be disabled to allow for cleaning or repositioning. See [Chapter 1, "Display"](#) for the location of the touchscreen deactivation button.

- To disable the touchscreen, press and hold the touchscreen deactivation button for one second. This button is to the left of the system power button at the bottom of the Display.
- While the touchscreen is inactive, the Display will remain on, but all touchscreen features will be disabled. An orange border is shown on screen during this time.
- To reactivate the touchscreen, press the same button until the orange border is removed.

Running a Case

Concluding a Case



To end the case, tap the *Home* button on the Taskbar:

To export case data, see [Chapter 5, "Data Export."](#)

Note: It is recommended to switch off the system when not in use.

Switching Off the System

To switch off the system, hold down the power button on the Display for two seconds.

Return the System to Preoperation State

When the system is paused or switched off, the user can return it to its preoperation state by following these steps:

1. Detach the BPM(s) from the BPM bracket.
2. Remove the CDI Shunt Sensor from the BPM by pinching the sensor wings and lifting the sensor off the BPM.
3. Dock the BPM(s) on the inner left or right holders on the back of the Display. While holding the sensor side towards the Display, align the grooves on both sides of the probe with the top of the holder, then slide downwards until the probe is flush against the bottom of the holder.
4. Detach the H/S(s) from the CDI H/S Cuvette(s) and dock it on either the outer left or right mount on the back of the Display. While holding the sensor side facing towards the Display, gently press it into the mount until it clicks into place.
5. Open Flow Sensor latch to remove tubing.
6. Wipe down the CDI OneView Display, Core and cables with an appropriate cleaning agent. See [Chapter 7, "Routine Cleaning"](#) for cleaning instructions and precautions.
7. If desired, a cable can be removed by gripping it by the connector barrel and pulling to release the latch.

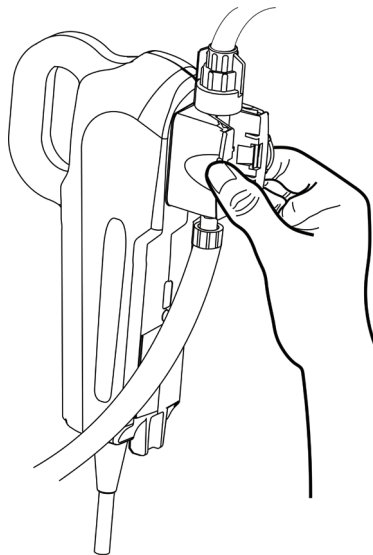

Running a Case

Disposal of Waste Products

Disposal of the CDI Shunt Sensors and CDI H/S Cuvette must be done along with the bypass tubing circuit. No disconnection or further handling of the CDI disposables is necessary. Use standard hospital protocol for disposal of the bypass tubing circuit, as well as CDI Shunt Sensors and H/S Cuvettes that have contacted blood.

CDI gases are contained in disposable gas bottles. These non-returnable bottles contain nontoxic, nonflammable gases and gas mixtures.

To dispose of a gas bottle:

1. To release residual pressure of the gas bottle, press inside the centermost point of the threaded portion of the valve. For gases or mixtures containing less than 21% oxygen, this should be done in a well-ventilated area to avoid asphyxiation by displacement of oxygen.
2. Remove or obliterate markings that indicate the bottle contains hazardous material.
3. Discard the bottle as you would other metallic or hard goods trash as permitted by local authorities, rules or regulations.

Note: To dispose by recycling, the valve must also be removed from the bottle, as it is made from a different type of metal.



Caution

- Do not dispose of the BPM(s), H/S(s) or Flow Sensor(s).

Running a Case

Data Export

The CDI OneView System can export both case data and log data to an external USB drive connected to the bottom of the Display.

- **Case data** includes all recorded data from a case, including events and screenshots.



- **Log data** includes technical alarms, physiological alarms, security events and errors.

Note: Loss of power, including battery depletion, does not affect alarm logs.

Note: When alarm logs are at maximum capacity, the oldest entry is overwritten.

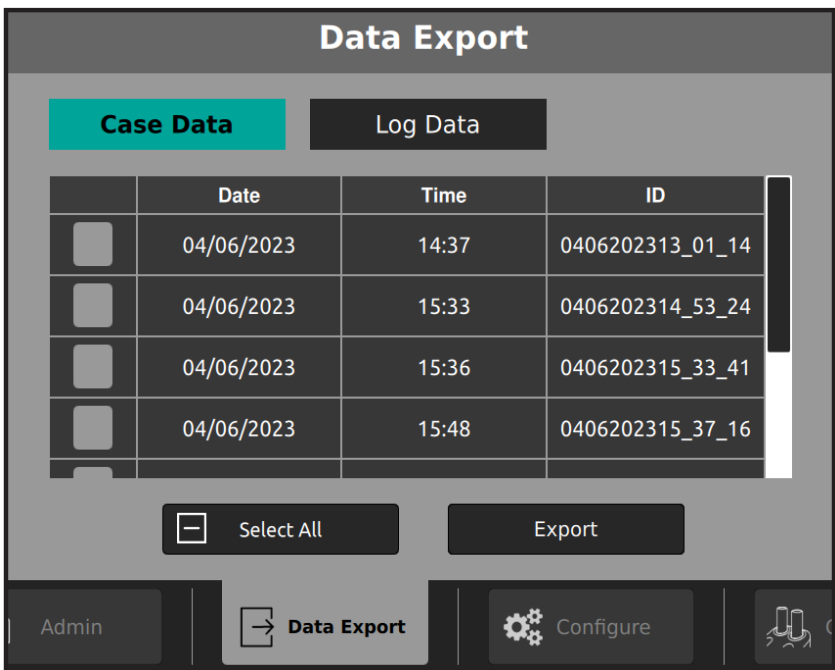

1. A USB drive must be connected to the Display to proceed.
2. On the **Data Export Tab**, tap the *Case Data* or *Log Data* button.
3. Tap the checkboxes on the leftmost column to select items. To select all items, tap the *Select All* button at the bottom.
4. Tap *Export*.

Upon successful export, a checkmark will appear above the export button.



Caution

- Do not connect an external USB drive to the system while still in Measurement Mode due to possible disruptions to the system if the drive is corrupt.

Troubleshooting

This chapter provides a list of error messages and suggested solutions for problems that might occur with the Terumo Cardiovascular CDI OneView™ System. If you see an error message or have a problem with the system, consult this chapter for assistance.

Report any serious incident in relation to the CDI OneView System to Terumo Cardiovascular and to the competent authority of the Member State in which the user and/or patient is established. For additional assistance with any problems or concerns, Terumo Cardiovascular troubleshooting hotlines are available during normal business hours:

-
- 800-521-2818 — Customer Administration
 - 800-441-3220 — Technical Support
-

Error Messages and Conditions

The CDI OneView System can diagnose many of the problems that might occur during use. When the system diagnoses a problem, an error message appears on screen.



Warning

- ✦ **Messages denoted as *Technical Alarm* will alarm with Medium Priority. During Technical Alarm conditions, the system may not accurately detect a physiological alarm.**



Caution

- *After shutting down the system, ensure the Core and Display LEDs are no longer flashing before powering on the system again. Flashing green LEDs indicate the system is not ready to power on.*

The tables on the following pages list possible error conditions along with any associated error messages, then provide explanations and what can be done to correct each condition.

Troubleshooting

STARTUP	
Message	Meaning and Corrective Action
System will not power on	<p>Ensure the Core is securely plugged into an AC power outlet by confirming the white indicator lights on both the Core and Display are illuminated.</p> <p>Note: System will not power on while on battery power.</p> <p>If connected to AC power and the Core indicator light is not illuminated, check the fuses located by the AC power port on the Core. If a fuse is blown, replace it with a 3.15 ampere (5mm x 20mm, 250V) slow-acting fuse.</p> <p>If the Display indicator light is not illuminated, confirm the Display cable is securely connected to both the Core and Display. If still not illuminated, try a replacement Display cable.</p> <p>If the issue persists, contact Terumo Cardiovascular Technical Support.</p>
Battery error C504	<p>A failure was detected in the battery during system startup. The system can continue to be used while connected to AC power.</p> <p>Contact Terumo Cardiovascular Technical Support.</p>
System error C505	<p>A failure was detected in the Core electronics.</p> <p>Contact Terumo Cardiovascular Technical Support.</p>

SYSTEM	
Message	Meaning and Corrective Action
<p>Technical Alarm</p> <p>Battery low Shutdown in less than 5 minutes</p>	<p>The system will alarm when operating on battery with less than 5 minutes of charge remaining.</p> <p>Connect to AC power.</p> <p>Note: Connecting to AC power will deactivate the alarm.</p>

Troubleshooting

SYSTEM	
Message	Meaning and Corrective Action
Battery communication error C022	<p>The Core detects a communication failure with the battery. Battery backup may not be available until the issue is resolved.</p> <p>Power off the system, wait for Core LED to turn steady white, and then power system back on. If the issue persists, contact Terumo Cardiovascular Technical Support.</p>
Communication error with <i>(Module)</i> C022	<p>The system detects a communication error between the Core and a given module.</p> <p>Disconnect and reconnect the module, try a different port on the Core or try a replacement module. If the issue persists, contact Terumo Cardiovascular Technical Support.</p>
Check <i>(Module)</i> connection C023	<p>The system detects a module has been disconnected from the Core while in Measurement Mode, or the Calibrator has been disconnected during calibration and calibration will be stopped.</p> <p>If the module was not intentionally disconnected from the Core, disconnect and reconnect the module, try a different port on the Core or try a replacement module. If the issue persists, contact Terumo Cardiovascular Technical Support.</p>
Core error C501	<p>A read/write failure was detected in the Core electronics.</p> <p>Contact Terumo Cardiovascular Technical Support.</p>
Battery not charging C540	<p>The battery has failed to recharge. If used on battery, the system will deplete any remaining charge. Once depleted, the battery will no longer be functional. The system can continue to be used while connected to AC Power.</p> <p>Contact Terumo Cardiovascular Technical Support.</p>
Battery capacity low C550	<p>The battery capacity has degraded past system specifications.</p> <p>Contact Terumo Cardiovascular Technical Support.</p>

Troubleshooting

SYSTEM	
Message	Meaning and Corrective Action
Display error D501	<p>A read/write failure was detected in the Display electronics.</p> <p>Contact Terumo Cardiovascular Technical Support.</p>
System communication error D502	<p>The system detects a communication error between the Core and Display. The system connections cannot be managed by the Display.</p> <p>Ensure Display cable is properly connected to the Core and Display. Power off the system, wait for Core LED to turn steady white, and then power system back on. If the issue persists, contact Terumo Cardiovascular Technical Support.</p>
Data transfer failure D503	<p>Data could not be transferred to/from an external hard drive.</p> <p>Try a different external hard drive. If the error persists, contact Terumo Cardiovascular Technical Support.</p>
Barcode read error D504	<p>The barcode camera cannot successfully scan a barcode.</p> <p>Try repositioning the barcode beneath the camera at a proper distance. If the barcode scan continues to be unsuccessful, contact Terumo Cardiovascular Technical Support.</p>

Troubleshooting

GAS CALIBRATION	
Message	Meaning and Corrective Action
<p>Calibration function is unavailable</p> <p>BPM</p>	<p>The system will not initiate calibration if BPM(s) are not detected.</p> <p>Ensure proper placement of the BPM(s) in the Calibrator. The BPM is seated properly if it can resist a gentle tug. Ensure the BPM(s) are properly connected to the Core. If the issue persists, contact Terumo Cardiovascular Technical Support.</p>
<p>No gas flow (<i>Left or Right</i>)</p> <p>G405 G406</p>	<p>The calibration gas is not flowing freely through the sensor during calibration. The <i>left</i> or <i>right</i> designation indicates which calibration pocket is affected. This can be caused by closed venting caps, blocked gas ports or blocked filter/sparger assemblies.</p> <p>Ensure the large blue venting cap(s) on the top of the Shunt Sensor(s) are loosened and that the blue Luer cap(s) on the filter(s) are removed. Ensure the BPM(s) are securely seated in the Calibrator. Retry calibration. If still no gas flow is detected, replace the Shunt Sensor(s) and try again.</p> <p>If the problem persists after several retries, contact Terumo Cardiovascular Technical Support.</p>
<p>No (<i>Arterial or Venous</i>) Flow Detected</p> <p>G436 G437</p>	<p>The Arterial or Venous Shunt Sensor is not responding to gas flow during calibration. This can be caused by closed venting caps or compromised sensors.</p> <p>Ensure the large blue venting cap(s) on the top of the Shunt Sensor(s) are loosened. If the proper setup was confirmed, this indicates the problem is with the Shunt Sensor(s). Replace the Shunt Sensor(s) and try again. If the problem persists, contact Terumo Cardiovascular Technical Support.</p>

Troubleshooting

GAS CALIBRATION	
Message	Meaning and Corrective Action
<p>(Arterial or Venous) BPM calibration failure (pH, pCO₂, pO₂, K⁺ intensity/slope)"</p>	<p>Shunt Sensor(s) have failed the calibration range check to ensure proper performance per parameter. This includes one or more of the following: arterial pH, pCO₂, pO₂, K⁺ and/or venous pH, pCO₂, pO₂, K⁺.</p> <p>Retry gas calibration with new Shunt Sensor(s). It is not recommended to repeat gas calibration using the same Shunt Sensor. Buffer solution in the sensor is lost during gas calibration, and insufficient buffer solution may result in an inaccurate gas calibration.</p> <p>Ensure the sensor(s) are fully and properly engaged with the BPM(s). Ensure proper placement of the BPM(s) in the Calibrator. If the issue persists, contact Terumo Cardiovascular Technical Support.</p> <p>Note: if you are calibrating both Arterial and Venous BPM assemblies and only one side fails, the passing side will retain its new calibration data.</p>
<p>Calibrator Error G006 G007 G010 G001 G008 G011</p>	<p>A problem was detected in the Calibrator electronics.</p> <p>It may be possible to reset the system by disconnecting and reconnecting to the Core. If the issue persists, contact Terumo Cardiovascular Technical Support.</p>
<p>Barometric pressure outside operational range G400</p>	<p>This indicates an ambient pressure measurement outside the acceptable range.</p> <p>Confirm the device is being used within the environmental specifications listed in Appendix B. If the error persists, a hardware failure is suspected. Contact Terumo Cardiovascular Technical Support.</p>
<p>Gas (1 or 2) pressure sensor error G401 G402</p>	<p>The system is detecting gas bottle pressure out of range.</p> <p>Try replacing the corresponding gas bottle. If the error persists, a hardware failure is suspected. Contact Terumo Cardiovascular Technical Support.</p>

Troubleshooting

GAS CALIBRATION	
Message	Meaning and Corrective Action
Number of calibrations displays "- -" <i>or</i> Replace Gas (1 or 2) G403 G404 G417 G419	<p>One or both of the gas bottles in the Calibrator has insufficient gas to complete a calibration.</p> <p>Replace the empty gas bottle(s) and confirm gas bottles have been secured in the gas slot(s) by turning until resistance is felt. If the error persists, contact Terumo Cardiovascular Technical Support.</p>
Calibration Error G409 G410	<p>The Calibrator detects gas leakage. Replace the gas bottle(s).</p> <p>Confirm gas bottles have been secured in the gas slot by turning until resistance is felt.</p>
Calibration interrupted Calibration has been aborted G413	<p>Calibration was interrupted due to changing the number of BPM(s) in the Calibrator after calibration was initiated. The calibration process must be restarted with the intended number of BPM(s).</p> <p>Note: You will need to replace the Shunt Sensor(s) on the BPM(s) before restarting calibration.</p>
Calibration Error G415 G416 G418	<p>An issue was detected with the internal pressure valves in the Calibrator. It may be possible to reset the system by disconnecting and reconnecting it to the Core. If the issue persists, contact Terumo Cardiovascular Technical Support.</p> <p>Note: You will need to replace the Shunt Sensor(s) on the BPM(s) before restarting calibration.</p>
(<i>Arterial or Venous</i>) sensor timeout G420 G421 G422 G423	<p>A Shunt Sensor did not respond to the calibration gas in the time expected.</p> <p>Retry calibration for the BPM(s) with new Shunt Sensor(s). Ensure the sensor(s) are properly engaged with the BPM(s). Ensure proper placement of the BPM(s) in the Calibrator. If the issue persists, contact Terumo Cardiovascular Technical Support.</p>

Troubleshooting

GAS CALIBRATION	
Message	Meaning and Corrective Action
<p>(Arterial or Venous) BPM error</p> <p>G424 G425</p>	<p>A BPM error occurred during calibration.</p> <p>It may be possible to reset the BPM by disconnecting and reconnecting it to the Core. If the issue persists, use a replacement BPM and contact Terumo Cardiovascular Technical Support.</p>
<p>Improper gas bottle detected</p> <p>G429 G432</p>	<p>Monitoring during calibration indicates that the gas bottles are likely not in the proper position.</p> <p>Confirm Gas 1 and Gas 2 are placed in their corresponding gas slots. If proper gas bottle positioning has been confirmed and the issue persists, contact Terumo Cardiovascular Technical Support.</p>
<p>(Arterial or Venous) air equilibration error</p> <p>G430 G431</p>	<p>The system has detected a very low CO₂ level in the Shunt Sensor which could impact system performance. This could indicate that the sensor foil package had a leak in it or that the sensor was exposed to room air for more than 24 hours.</p> <p>Retry calibration for this BPM with a new Shunt Sensor. If the foil pouch is visibly compromised, please keep the foil pouch and contact Terumo Cardiovascular Technical Support.</p>
<p>Calibration error calculation timeout</p> <p>G434 G435</p>	<p>There is a communication issue preventing the completion of the calibration process.</p> <p>Retry a calibration with new Shunt Sensor(s). If the issue persists, contact Terumo Cardiovascular Technical Support.</p>

Note: A partial failure of calibration indicates the calibration was only successful for one of two BPMs. You can retry calibration on the failed BPM with a new Shunt Sensor. Do not redo calibration on the BPM that successfully completed calibration.

Note: Most calibration failures will allow continued operation of the system without successful completion of the calibration process. Continued operation will use the last successful calibration values. If you choose to proceed, parameter values for pH, PCO_{2t}, PO_{2t}, and K⁺ from the uncalibrated BPM may not be accurate.

Troubleshooting

BPM PROBE	
Message	Meaning and Corrective Action
<p>(Arterial or Venous) BPM-[SM] error</p> <p>B001 B002 B004 B006 B007 B008 B010 B102</p>	<p>A problem detected with the BPM Probe electronics.</p> <p>It may be possible to reset the BPM Probe by disconnecting and reconnecting it to the Core. If the issue persists, use a replacement BPM Probe and contact Terumo Cardiovascular Technical Support.</p>
<p>(Arterial or Venous) BPM-[SM] SRS failure</p> <p>B100</p>	<p>This failure indicates a probe has failed its reference sensor test.</p> <p>Ensure the BPM optical head is clean, undamaged and not placed directly next to a light source. To repeat the test, disconnect and reconnect the BPM Probe to the Core. If the issue persists, use a replacement BPM Probe and contact Terumo Cardiovascular Technical Support.</p>
<p>(Arterial or Venous) BPM-[SM] Temperature Range Error</p> <p>B101</p>	<p>The BPM Probe temperature measurement is out of system range.</p> <p>Confirm the BPM Probe is being used within the specified environmental conditions in Appendix B. Disconnect and reconnect the BPM Probe to the Core. If the error persists, use a replacement BPM Probe and contact Terumo Cardiovascular Technical Support.</p>
<p>(Arterial or Venous) BPM-[SM] Sensor Intensity Error</p> <p>B103</p>	<p>The BPM Probe sensor intensity measurement is out of system range.</p> <p>Confirm secure placement of the Shunt Sensor in the BPM optical head. If the error persists, use a replacement BPM Probe and contact Terumo Cardiovascular Technical Support.</p>
<p>(Arterial or Venous) BPM-[SM] error</p> <p>B104</p>	<p>The calibration data stored on the Probe has been corrupted.</p> <p>Use a replacement BPM Probe and contact Terumo Cardiovascular Technical Support.</p>

Troubleshooting

BPM PROBE	
Message	Meaning and Corrective Action
<p>(Arterial or Venous) BPM-[SN] Reference Intensity Error</p> <p>B108</p>	<p>The BPM Probe internal reference intensity measurement is out of system range.</p> <p>Confirm the BPM Probe is being used within the specified environmental conditions in Appendix B. Ensure the BPM Probe is not placed directly next to a light source. To retry the BPM Probe, disconnect and reconnect to the Core. If the error persists, use a replacement BPM Probe and contact Terumo Cardiovascular Technical Support.</p>

H/S PROBE	
Message	Meaning and Corrective Action
<p>(Arterial or Venous) H/S-[SN] error</p> <p>H001 H002 H004 H006 H007 H008 H010 H011 H012 H013 H014</p>	<p>A problem was detected in the H/S Probe electronics.</p> <p>It may be possible to reset the H/S Probe by disconnecting and reconnecting it to the Core. If the issue persists, use a replacement H/S Probe and contact Terumo Cardiovascular Technical Support.</p>
<p>(Arterial or Venous) H/S Cuvette error</p> <p>H150</p>	<p>The H/S Probe cannot properly detect the Cuvette.</p> <p>Replace the Cuvette and contact Terumo Cardiovascular Technical Support.</p>
<p>(Arterial or Venous) H/S-[SN] Color Chip test failure</p> <p>H151</p>	<p>An H/S Probe has failed its color chip test.</p> <p>Ensure H/S optical head is clean, undamaged and not placed directly next to a light source. To repeat the test, tap <i>Retry</i> from the Message Center. If the issue persists, use a replacement H/S Probe and contact Terumo Cardiovascular Technical Support.</p>

Troubleshooting

H/S PROBE	
Message	Meaning and Corrective Action
Connect (<i>Arterial</i> or <i>Venous</i>) H/S to Cuvette H152	The H/S Probe detects when it is still connected to a color chip in Measurement Mode. The system will not report values while connected to a color chip. Remove the H/S Probe from the color chip and attach the Cuvette to obtain measurement values.
Technical Alarm Cuvette not detected on (<i>Arterial</i> or <i>Venous</i>) H/S	The system will alarm when measurement is active and a Cuvette is not detected by the H/S Probe. Connect the H/S Probe to the Cuvette. Ensure the release lever of the H/S Probe is latched by pressing the Probe and Cuvette together. If the alarm continues, replace the Cuvette and contact Terumo Cardiovascular Technical Support. Note: Connecting the H/S Probe to the Cuvette will deactivate the alarm.

FLOW INTERFACE MODULE AND SENSOR	
Message	Meaning and Corrective Action
(<i>Name</i>) Flow Module-[SN] error F001 F004 F006 F007 F008 F010 F011 F012 F013 F014 F055 F204 F205 F206 F207 F208	A problem was detected in the Flow Interface Module electronics. It may be possible to reset the Flow Interface Module by disconnecting and reconnecting it to the Core. If the issue persists, use a replacement Flow Interface Module and contact Terumo Cardiovascular Technical Support.

Troubleshooting

FLOW INTERFACE MODULE AND SENSOR	
Message	Meaning and Corrective Action
Flow Sensor-[SN] measurement error F015	This error indicates invalid Flow Sensor measurement readings. Try a replacement Flow Sensor. If the issue persists, contact Terumo Cardiovascular Technical Support.
Check Flow Interface Module-[SN] connection F050 F051 F052 F053	Data from the Flow Sensor is not being received or is invalid. Check the connection between the Interface Module and Flow Sensor, or use a replacement Flow Sensor and/or Interface Module. If the issue persists, contact Terumo Cardiovascular Technical Support.
Flow Sensor-[SN] error F200	A problem was detected in the Flow Sensor electronics. Try disconnecting and reconnecting the Flow Sensor to the Flow Interface Module, or use a replacement Flow Module. Contact Terumo Cardiovascular Technical Support.
Technical Alarm Verify Flow Sensor-[SN] coupling F201	The system will alarm when in Measurement Mode and the Flow Sensor is not properly coupled to tubing. Confirm the Flow Sensor is properly attached to the tubing. Confirm the Flow Sensor size matches the tubing (ID, OD) being used. If the alarm continues, replace the Flow Sensor and contact Terumo Cardiovascular Technical Support. Note: Proper coupling of the Flow Sensor to tubing will deactivate the alarm.
Flow Sensor-[SN] disconnected F202	The system detects that the Flow Sensor has been disconnected. To measure flow, connect a Flow Sensor. If this message appears when the Flow Sensor is connected to the module, try disconnecting and reconnecting the Flow Sensor to the Flow Interface Module, or use a replacement Flow Sensor. Contact Terumo Cardiovascular Technical Support.

Troubleshooting

FLOW INTERFACE MODULE AND SENSOR	
Message	Meaning and Corrective Action
<p>(Name) Flow Module-[SN] Sensor change</p> <p>F203</p>	<p>The system detected a change to the Flow Sensor size connected to a Flow Interface Module while in Measurement Mode.</p> <p>Confirm alarm limits are appropriate for the sensor. Confirm the Flow Sensor color identifier matches the configuration.</p>

HLM INTERFACE MODULE	
Message	Meaning and Corrective Action
<p>HLM Interface Module-[SN] failure</p> <p>P001 P004 P006 P007 P008 P010 P011 P012 P013 P014 P055 P056</p>	<p>A problem was detected in the HLM Interface Module electronics.</p> <p>It may be possible to reset the HLM Interface Module by disconnecting and reconnecting it to the Core. If the issue persists, use a replacement HLM Interface Module and contact Terumo Cardiovascular Technical Support.</p>
<p>Check HLM Interface Module-[SN] connection</p> <p>P050 P051 P052 P053 P054 P301</p>	<p>Data is invalid or is not being received from the source HLM/pump device while in Measurement Mode.</p> <p>Confirm the correct HLM is selected in the case profile. Check connections between the Core and the Interface Module and between the Interface Module and pump. Check the serial cable to ensure it is the right interface cable for that HLM. Ensure the HLM is configured per the instructions in Chapter 3, "Sensor Connections." Try a replacement serial cable and/or Interface Module. If the issue persists, contact Terumo Cardiovascular Technical Support.</p>

Troubleshooting

rSO ₂ INTERFACE MODULE	
Message	Meaning and Corrective Action
rSO ₂ Interface Module-[SN] failure X001 X004 X006 X007 X008 X010 X011 X012 X013 X014 X055	A problem detected in the rSO ₂ Interface Module electronics. It may be possible to reset the rSO ₂ Interface Module by disconnecting and reconnecting to the Core. If the issue persists, use a replacement rSO ₂ Interface Module and contact Terumo Cardiovascular Technical Support.
Check rSO ₂ Interface Module-[SN] connection X050 X051 X052 X053 X251	Data is invalid or is not being received from the source cerebral oximetry device while in Measurement Mode. Confirm the correct oximeter is selected in the case profile. Check the connection between the Interface Module and oximeter. Check the type of serial cable being used; the cable must be a straight through serial cable. Ensure the oximeter is configured per the instructions in Chapter 3, "Sensor Connections." If the issue persists, try a replacement Interface Module and contact Terumo Cardiovascular Technical Support.

DMS INTERFACE MODULE	
Message	Meaning and Corrective Action
DMS Interface Module-[SN] failure M001 M004 M006 M007 M008 M010 M011 M012 M013 M014 M055	A problem was detected in the DMS Interface Module electronics. It may be possible to reset the DMS Interface Module by disconnecting and reconnecting it to the Core. If the issue persists, use a replacement DMS Interface Module and contact Terumo Cardiovascular Technical Support.

Troubleshooting

DMS INTERFACE MODULE	
Message	Meaning and Corrective Action
Check DMS Interface Module-[SM] connection M052 M054	Data cannot be sent to the DMS. Check connections between the Core and Interface Module and between the Interface Module and Data Management System. Try a replacement Interface Module. If the issue persists, contact Terumo Cardiovascular Technical Support.

IN MEASUREMENT MODE	
Message	Meaning and Corrective Action
Recalibration not successful for: [parameters] Updates will not be made for these parameters.	The recalibration values are out of system range. Confirm the parameters being measured are within the operating range of the system prior to retrying recalibration. This may occur if you are using a BPM that has not been calibrated or has gone longer than 24 hours since calibration. It may also indicate an error with the Shunt Sensor, Cuvette or Probe hardware. Contact Terumo Cardiovascular Technical Support.
Parameter values show dashes (--)	Dashes are shown when parameter data is invalid. Reasons for invalid data are: <ul style="list-style-type: none"> • Values are outside the system display range (including negative flow reading from CDI Flow Sensors) • H/S Probe is still connected to a color chip • Required inputs are not available for calculation
Mark event unsuccessful D505	A marked event could not be saved. Retry marking the event. If the issue persists, contact Terumo Cardiovascular Technical Support.
Storage full D512	A screenshot could not be saved. Retry taking a screenshot. If the issue persists, contact Terumo Cardiovascular Technical Support.

Troubleshooting

Laboratory Comparison Troubleshooting Table

The following table details information you can use to determine why your CDI OneView System values appear to be inaccurate with respect to laboratory values:

PARAMETER ACCURACY	
Problem	Corrective Action
Accuracy problems? Has the circuit stabilized before drawing a laboratory comparison sample?	<ul style="list-style-type: none">• Wait approximately five minutes after making a change to blood flow rate, gas flow rate, FiO₂, temperature, etc. Watching the CDI OneView System parameter values for roughly one minute will indicate whether or not the circuit has stabilized. The graphics display is also helpful for checking blood parameter stability.• Check to see if the values measured 1-2 minutes after storing have moved closer to the corresponding lab values. If so, this suggests that dynamic blood parameter changes and the system's time response are responsible for the comparison difference. Performing an in vivo recalibration under these conditions is not recommended.• A blood flow rate of less than 35 mL/min in the CDI Shunt Sensor line may result in slower measurement response times. Restoration of the flow rate back above 35 mL/min will return the sensor readings to normal.• A minimum blood flow rate through the CDI H/S Cuvette may result in inaccurate saturation/hematocrit readings. Restoration of the flow rate back above minimum requirement will return the CDI H/S Cuvette readings to normal.• Air bubbles or fluid other than blood (such as medication given in the shunt line and passing the Shunt Sensor) will affect the Shunt Sensor readings intermittently. As soon as the air or fluid clears the Shunt Sensor, values will return to normal.• After changes of blood temperature of > 6°C, repeat an in vivo recalibration of Shunt Sensor values once temperature stability has been achieved. Optimal system accuracy will be maintained with this practice.

Troubleshooting

PARAMETER ACCURACY	
Problem	Corrective Action
<p>Accuracy problems? Does the lab temperature match the CDI OneView System temperature?</p>	<p>The temperature mode of the CDI OneView System recalled values must match what is used by the laboratory. If the laboratory values are reported at 37°C, ensure the comparison values at 37°C or changed to 37°C values after being recalled. Likewise, if the lab values are being reported at actual temperature, ensure the system values are stored in the actual temperature mode or changed to actual after being recalled. Verify the lab values are reported at the same temperature the system was using at the time the values were stored. Any differences will cause variation in the comparison.</p> <p>Note: The parameter values displayed in the recalibration screen are switchable to 37°C corrected or actual temperature values regardless of the temperature mode used when stored.</p>
<p>pCO₂ problems? What kind of prime are you using?</p>	<p>Certain primes, including Normosol-R, Plasma-Lyte A and Isolyte-S, contain acetic acid ions (acetate) that may adversely affect the CDI OneView System CO₂ sensor. To avoid this contamination, do the following before putting the sensors in line:</p> <ul style="list-style-type: none"> • Blow off enough CO₂ to raise the pH above 7.0 • Add HCO₃⁻ to the prime solution to raise the pH above 7.0 <p>OR</p> <ul style="list-style-type: none"> • Add the sensors at the last possible moment before going on bypass to limit exposure of the sensors to the acetic acid ions.
<p>K⁺ problems? What kind of prime are you using?</p>	<p>Exposure of the Shunt Sensor to prime solutions with pH less than 7.0 or greater than 7.8 pH units can interfere in the accurate measurement of potassium. To avoid K⁺ problems, do one of the following:</p> <ul style="list-style-type: none"> • Isolate the sensor by adding it just before the initiation of CPB or keep shunt lines closed. <p>OR</p> <ul style="list-style-type: none"> • Monitor pH levels in the prime in order to ensure the pH is within the 7.0 - 7.8 pH units range. <p>Exposure of the Shunt Sensor to prime solutions with a sodium measurement less than 120 or greater than 160 mEq/L can interfere in the accurate measurement of potassium.</p>

Troubleshooting

PARAMETER ACCURACY	
Problem	Corrective Action
pH problems? Freeze indicator problem?	The buffer in the sensors can freeze if exposed to below freezing temperatures. This will result in a positive pH offset while on bypass. Check the freeze indicator on the sensor box to see if the sensors have been exposed to freezing temperatures. If the freeze indicator is positive, contact Terumo Cardiovascular Customer Administration or your local Terumo Cardiovascular Sales representative.
Are your pO ₂ values much higher than the lab?	<ul style="list-style-type: none"> • Check to make sure halothane is not being used as an anesthetic agent. Halothane presence in the blood will be measured as O₂ presence. • At very high pO₂ levels, some laboratory electrode signals can taper off and show lower than actual pO₂ values. Check to see if the lab can be tested at high pO₂ calibration values.
Does your lab sample have air bubbles in it?	Air bubbles in the syringe can cause the pO ₂ and the pCO ₂ to go towards room air values (towards 150 mmHg for pO ₂ and towards 0 mmHg for pCO ₂). The longer it takes for the lab sample to be analyzed, the more pronounced the room air contamination will be.
DO ₂ or VO ₂ calculation is off?	<ul style="list-style-type: none"> • Ensure you have the correct patient BSA entered. • If using only venous side measurement probes, ensure your arterial side saturation is correctly set. • Verify the saturation, hematocrit and flow values used are correct. If you are using arterial and venous BPMs but no H/S, the hematocrit value must be supplied manually, and the saturation values are calculated.
pO ₂ and pCO ₂ values have decimal points?	Check case profile configuration and make sure your data units are correct (mmHg or kPa).
Saturation/Hgb values are off?	<ul style="list-style-type: none"> • Check data options and make sure the saturation, hematocrit and hemoglobin offsets are being used correctly for your institution. • Check the optical interface material on the CDI H/S Cuvette to make sure it is undamaged, fully attached and not contaminated by any debris. • Check the optical surface of the CDI H/S Probe to make sure it is not scratched, damaged or contaminated by any debris.

Routine Maintenance and Disposal

The CDI OneView System requires minimal routine maintenance, including battery charging and surface cleaning. This chapter provides instructions for these two tasks, as well as recommended routine maintenance.

Note: If there are components or system operations that are not functioning properly, see [Chapter 6, “Troubleshooting”](#) for help. If the issue is not resolved after consulting Chapter 6, contact your Terumo Cardiovascular Technical Service representative or customer administration. [Appendix E, “Warranty and Service”](#) describes the service policy and gives phone numbers you can call for help.



Warning

✦ **Switch off the system power before inspection, cleaning or storage.**

Routine Cleaning

To keep the CDI OneView System working properly, follow the guidelines listed below. In addition to these cleaning instructions, comply with your institution’s cleaning practices and applicable AmSECT guidance. For additional information about reprocessing the device or details of the validation performed, contact Terumo Cardiovascular Technical Support.

- It is best to clean up any splatter or spill before it dries.
- Ensure the optical pathways stay clean and free of surface cuts, abrasions and contamination.
- Check the optical pathways regularly for damage and debris, paying special attention to the face of the BPM, the CDI H/S face and the optical reference color chips.
- If the optical pathway surfaces need cleaning, use a soft, lint-free, damp cloth with water to remove any foreign material. Dry the surface thoroughly with a clean, dry and soft lint-free cloth.
- For daily cleaning of the brackets and cables, use ordinary soap and water and a soft, lint-free, damp cloth. If liquid accidentally spills onto the Display, Core or Calibrator, clean up the spill as soon as possible to prevent the liquid from settling into the joints.
- The Flow Sensors cables and color-coded identifiers should be cleaned with a solution of mild soap and warm water.
- To clean the touchscreen and all external surfaces of the system (excluding optical pathways), the following cleaning solutions may be used:
 - ◇ Detergent soap and water
 - ◇ Isopropyl alcohol 70% solution
 - ◇ Ethyl alcohol 70% solution
 - ◇ Chlorine bleach ($\leq 0.6\%$ sodium hypochlorite)
 - ◇ Hydrogen peroxide (3%)
 - ◇ Quaternary ammonium chlorides (0.4%)
 - ◇ Phenolic cleaners (0.7%)

Routine Maintenance and Disposal

- Follow the manufacturer's instructions for preparation, handling, and use of the cleaning agent.
- After cleaning, visually verify contamination is removed and inspect parts for any visual damage. If contamination is still visible, repeat cleaning process. Contact Terumo Cardiovascular Technical Support if any parts appear damaged.
- Use proper disposal suggested for the cleaning agent used.

Note: To disable the touchscreen for cleaning, see [Chapter 5, "Touchscreen Deactivation."](#)

Observe the following precautions during cleaning:



Caution

- *Do not expose the ends of the optical fibers in the BPM(s), the optical probe face or the optical reference color chip to chemicals such as organic solvents, acids, strong bases or abrasives. These chemicals can cause degradation in the performance of the optical components. Use only water with a soft, lint-free cloth to clean these surfaces.*
- *Do not use harsh cleaning solutions on the cable connectors. These can cause damage to the finish or the integrity of the surfaces.*
- *Do not use abrasive materials in cleaning the display screen. This can cause degradation of the touchscreen functionality.*

Note: Check the calibration fluid residue in the calibrator pockets and on the BPMs themselves.

Note: Do not submerge any part of this device in any liquid.

Battery Maintenance

A battery replacement message will appear at each startup when the battery is no longer able to support the device for 25 minutes. The system will remain fully functional while connected to AC power. When the battery replacement message appears on the screen, contact your local Terumo Cardiovascular representative or call (800) 521-2818 for service.

Routine Maintenance and Disposal

Replacement Procedures

Aside from replacing the fuses for the AC power line and the H/S Probe spring clip, there are no further maintenance or repair procedures that can be performed at the institution. Please contact your Terumo Cardiovascular Technical Service representative for any additional technical service needs.

H/S Probe Spring Clip Replacement

The spring clip is the contoured, dark grey piece on the top of the H/S Probe. To replace a spring clip:

1. Hold the H/S Probe with the sensor facing towards you and the LED indicator facing away from you.
2. With your thumb, push forward against the flat side of the spring clip until it clicks out of place, then slide the spring clip away from you.
3. Align the new spring clip between the grooves at the top of the H/S Probe, then slide it towards you until it clicks into place.



Fuse Replacement



Warning

- ✦ **Before replacing the fuse, disconnect the Core from the wall power source.**
- ✦ **Replacement fuses must be the correct size and rating to protect against the risk of fire.**

The CDI OneView System fuses can be replaced. To test and/or change the fuses:

1. Remove the fuse holder from the back of the Core.
2. Test the continuity of the fuse(s), checking to see if they are blown.
3. Replace the fuse(s) as needed.

The two fuses used are identical:

3.15A @250 V, Slow Acting, High Breaking Capacity (1500A), 5mm X 20mm fuses.

Make sure the fuses are correctly replaced in the Core fuse holder.

System Disposal

The CDI OneView Core, Display, Calibrator, BPM, H/S, Modules, Flow and batteries must be disposed of in accordance with hospital policy regarding electrical and electronic equipment waste.

Refer to [Chapter 5, "Disposal of Waste Products"](#) for disposal of CDI Shunt Sensors, H/S Cuvettes and calibration gas cylinders.

System Components

Description	Catalog #	
CDI OneView Processing Core	CDI750	
CDI OneView Touchscreen Display	CDI751	
CDI OneView BPM Probe	CDI753	
CDI OneView H/S Probe	CDI754	
CDI OneView Calibrator	CDI740	
CDI OneView Calibrator Cable	CDI741	
CDI OneView Calibration Gas 1	CDI746	
CDI OneView Calibration Gas 2	CDI747	
Brackets		
CDI OneView Core Bracket	CDI780	
CDI OneView Display Bracket	CDI781	
CDI OneView BPM Bracket	CDI782	
CDI OneView Calibrator Bracket	CDI783	
Flow Components	Size	
CDI OneView Flow Interface Module	CDI760	
CDI OneView Flow Sensor	3/8" x 3/32"	CDI763
	1/4" x 3/32"	CDI764
	1/4" x 1/16"	CDI768
Sensor Identifier Kit	9002635	
Disposables	Size	
CDI Shunt Sensor (sterile, heparin-treated, case of 20 each)	CDI510H	
CDI H/S Cuvette (sterile, case of 20 each)	1/4"	6914
	3/8"	6913
	1/2"	6912
CDI H/S Cuvette with 6" (15.2 cm) extension tube (sterile, case of 10 each)	1/4"	6934
	3/8"	6933
	1/2"	6932

System Components

Description	Catalog #
External Data Modules	
CDI OneView HLM Interface Module	CDI770
CDI OneView DMS Interface Module	CDI771
CDI OneView RSO ₂ Interface Module	CDI772
Accessories	
CDI Module for Terumo Advanced Perfusion System 1	803479
CDI Interface Cable for Terumo Advanced Perfusion System 1	804981

System Specifications

Manufacturer-Defined Default Alarm Limits

The CDI OneView System provides alarm functionality for the parameters the system is capable of measuring in accordance with the IEC 60601-1-8:2006+A1:2012, Medical electrical equipment – Part 1-8: General requirements for basic safety and essential performance – Collateral standard: General requirements, tests and guidance for alarm systems in medical electrical equipment and medical electrical systems.

Based on these requirements and the known clinical use of the CDI OneView System, manufacturer-defined default limits provide alarm functionality at the medium-priority level. Physiological alarm priorities were established for both **out of range – High** and **out of range – Low** parameter values based on the potential harm to the patient and the time to occurrence of harm if the alarm is ignored.

Medium Priority conditions are defined in the standard as conditions that can result in:

- reversible injury within a time period sufficient for manual corrective action.
- death or irreversible injury within an unspecified time greater than prompt.
- minor injury or discomfort within a time period not usually sufficient for manual corrective action.

Parameter	Default Alarm-Min		Default Alarm-Max	
pH	A: 7.10	V: 7.00	A: 7.65	V: 7.65
pCO ₂	A: 30 mmHg	V: 35 mmHg	A: 55 mmHg	V: 60 mmHg
pO ₂	A: 85 mmHg	V: 30 mmHg	A: 500 mmHg	V: 65 mmHg
K ⁺	3.0 mmol/L		7.0 mmol/L	
SO ₂	A: 85%	V: 60%	A: 100%	V: 95%
HCT	21%		45%	
Hgb	7.0 g/dL		15 g/dL	
Q̇	0.05 L/min		8.00 L/min	
CI	0.1 L/min/m ²		10.0 L/min/m ²	
BE	-25 mEq/L		25 mEq/L	
HCO ₃ ⁻	0 mEq/L		50 mEq/L	
VO ₂	1 mL/min		400 mL/min	
VO ₂ i	1 mL/min/m ²		1000 mL/min/m ²	
DO ₂	50 mL/min		3000 mL/min	
DO ₂ i	262 mL/min/m ²		1000 mL/min/m ²	
O ₂ ER	0%		40%	
SaSO ₂ calc	85%		100%	
SvSO ₂ calc	60%		95%	

System Specifications

System Operating Ranges

System Operating Ranges are the ranges in which parameter measurement performance meets system accuracy limits when adhering to instructions for use.

Parameter	Operating Range
pH	6.80 to 7.65
pCO ₂	10 to 80 mmHg
pO ₂	20 to 500 mmHg
K ⁺	3.0 to 8.0 mmol/L
Shunt Temp	15° to 40° C
SO ₂	60 to 100%
HCT	15 to 45%
Hgb	5 to 15 g/dL
Q̇	Per tubing size: 3/8" → 0.20 to 8.00 L/min 1/4" → 0.05 to 2.50 L/min

Note: The system is intended to be used only within the above "System Operating Ranges" for the System Accuracy Limits. Values outside of these ranges will be displayed and an alarm will be triggered, except for BE, Temperature and Arterial SO₂.

System Specifications

System Display Ranges

System Display Ranges are the full ranges in which parameter values will be displayed by the system.

Parameter	Display Range	Resolution (*)
pH	6.50 to 8.50	0.01
pCO ₂	10 to 200 mmHg 1.3 to 26.7 kPa	1 0.1
pO ₂	10 to 700 mmHg 1.3 to 93.3 kPa	1 0.1
K ⁺	1.0 to 9.9 mmol/L	0.1
Shunt Temp	1.0 to 45.0 °C	0.1
SO ₂	35 to 100%	1%
HCT	12 to 45%	1%
Hgb	4.0 to 15.0 g/dL 40 to 150 g/L	0.1
Q̇	0 to 10.00 L/min 0 to 10,000 mL/min	0.001 < 1.0 L/min 0.01 ≥ 1.00 L/min
CI	0.1 to 10.0 L/min/m ²	0.1
BE	-25 to 25 mEq/L	1
HCO ₃ ⁻	0 to 50 mEq/L	1
VO ₂	1 to 400 mL/min	1
VO ₂ i	1 to 1000 mL/min/m ²	1
DO ₂	1 to 3000 mL/min	1
DO ₂ i	1 to 1000 mL/min/m ²	1
rSO ₂	match source device	match source device
O ₂ ER	0 to 100%	1%
SaSO ₂ calc	35 to 100%	1%
SvSO ₂ calc	35 to 100%	1%

(*) When no unit is listed, the same unit as listed in the Display range applies.

System Specifications

System Accuracy

The CDI OneView System has been subjected to rigorous bench tests to simulate clinical use of the device and assess its accuracy and precision over the system operating ranges of measured parameters. Blood samples taken from the test circuit were analyzed in conventional analyzers, and these results were compared on a sample-by-sample basis to values displayed by the CDI OneView System. The absolute values of the differences were then used to calculate error for each measurement.

$$Error = |CDI - Analyzer|$$

The population of errors for each sensor is summarized statistically using a Weibull Distribution.

Note: This analysis method using absolute value utilizes a different statistical approach from legacy CDI products that is more suitable for the distribution of data across all operating conditions. Therefore the statistical summary should not be used for direct comparison to legacy CDI product performance specifications.

Sensor	Median Error	Standard Deviation
pH (pH units)	0.01	0.02
pCO ₂ (mmHg)	1.35	0.96
pO ₂ Arterial (>80 mmHg)	7.24	1.48
pO ₂ Venous (<80 mmHg)	1.22	0.85
SO ₂ (%)	0.69	0.85
Total HGB (g/dL)	0.44	0.40
K ⁺ (mmol/L)	0.15	0.09
HCT (%)	1.35	1.19
Flow Sensor Q̇		
1/4" x 1/16" (% of reading)	3.77	7.54
1/4" x 3/32" (% of reading)	4.26	6.76
3/8" x 3/32" (% of reading)	4.82	2.13

System Specifications

System Accuracy Limits		
Parameter	Operating Range	Post In Vivo Performance
pH	6.80 to 7.65	±0.070 pH units for ≥6.80 and <7.30 ±0.050 pH units for ≥7.30 and ≤7.50 ±0.070 pH units for >7.50 and ≤7.65
pCO ₂	10 to 80 mmHg	±5.0 mmHg for ≥10 mmHg and ≤55 mmHg ±10% for >55 mmHg and ≤80 mmHg
pO ₂	20 to 500 mmHg	±5.0 mmHg for ≥20 mmHg and ≤50 mmHg ±10% for >50 mmHg and ≤500 mmHg
K ⁺	3.0 to 8.0 mmol/L	±0.6 mmol/L
SO ₂	60 to 100%	±4%
HCT	15 to 45%	±4%
Hgb	5 to 15 g/dL	±1.3
Tubing ID	Flow Rate	Accuracy
3/8"	0.20 - 8.0 L/min	±60 mL/min for flow rates ≤ 600 mL/min ±10% of true flow for flow rates above 600 mL/min
1/4"	0.05 - 2.5 L/min	±30 mL/min for flow rates ≤ 300 mL/min ±10% of true flow for flow rates above 300 mL/min

System Specifications

Environmental Specifications

Operating Conditions	
Temperature	10 °C to 40 °C (50 °F to 104 °F)
Humidity	30% to 75%
Storage Temperatures	
Hardware	10 °C to 40 °C (50 °F to 104 °F)
Shunt Sensors	0 °C to 35 °C (32 °F to 95 °F)
Calibration Gas 1 and 2	18 °C to 25 °C (64.4 °F to 77 °F)
Transport Temperatures	
Hardware	-20 °C to 60 °C (-4 °F to 140 °F)
Shunt Sensors	0 °C to 35 °C (32 °F to 95 °F)
Calibration Gas 1 and 2	-20 °C to 55 °C (-4 °F to 131 °F)
Storage Humidity	
Hardware	≤ 75% (non-condensing)
Shunt Sensors	5% to 95% (non-condensing)
Calibration Gas 1 and 2	No limits
Transport Humidity	
Hardware	10% to 95% (non-condensing)
Shunt Sensors	15% to 90% (non-condensing)
Calibration Gas 1 and 2	No limits
Atmospheric Pressure:	500 to 800 mmHg
Vibration/Shock:	Proper performance of the system depends upon high-fidelity optical alignment. Avoid vibration and dropping components or cable-heads.

System Specifications

Electrical Specifications

Core Power	
AC	100-240 VAC 50/60 Hz 170 VA
Battery	Type: Lithium-ion Voltage: 14.4 VDC Operating time: 25 minutes under maximum load Compliance: IEC 62133, PSE

Note: To provide isolation from supply mains, remove power cord from the CDI OneView System appliance coupler. Do not position the CDI OneView System so that it is difficult to isolate the appliance coupler from the supply mains.

Device Classification	
Electric Shock Protection	Class I Defibrillator-proof type CF applied part
Electromagnetic Emissions	Group 1/Class A with respect to CISPR 11
Mode of Operation	Continuous
Electromagnetic Compatibility	IEC 60601-1-2:2014+A1:2020 IEC 80601-2-49:2018

Ingress Protection	IP Rating
Display and Core	IP32
BPM Probe	IPX4
Calibrator, H/S Probe, Modules, Flow Sensor	IPX2

System Specifications

Classifications:

This equipment is Type CF and Class 1. Listed by Intertek with respect to electrical shock, fire and mechanical hazards in accordance with IEC 60601-1:2005+A1:2012+A2:2020 and CAN/CSA No. 60601-1:14:2014.

In accordance with IEC 60601-1: This equipment has been tested and found to comply with the limits for medical devices to the IEC 60601-1-2:2014. These limits are designed to provide reasonable protection against harmful interference in a typical medical installation. This equipment generates, uses and can radiate radio frequency energy and, if not installed and used in accordance with the instructions, may cause harmful interference to other devices in the vicinity. However, there is no guarantee that interference will not occur in a particular installation.

If this equipment does cause harmful interference to other devices, which can be determined by switching the equipment off and on, the user is encouraged to try to correct the interference by one or more of the following measures:

- Reorient or relocate the receiving device.
- Increase the separation between the equipment.
- Connect the equipment into an outlet on a circuit different from that to which the other device(s) are connected.
- Consult the manufacturer of the receiving device for help.

Electromagnetic Compatibility (EMC)

The CDI OneView System is suitable for use only in the electromagnetic environments specified in the following tables, in accordance with these standards:

- IEC 60601-1:2005+A1:2012+A2:2020
- IEC 60601-1-2:2014+A1:2020
- IEC 80601-2-49:2018

Note: The emission characteristics of this equipment make it suitable for use in industrial areas and hospitals (CISPR 11, Class A). If used in a residential environment (for which CISPR 11 Class B is normally required), the system might not offer adequate protection from radio frequency interference. The user might need to mitigate this possibility by relocating or reorienting the equipment. The system is not indicated for use in transportation environments, such as on aircraft.

System Specifications

Electromagnetic Emissions Guidelines and Compliance

The CDI OneView System is intended for use in the electromagnetic environment specified in the following tables. The user of the system must ensure it is used in such an environment.

Guidance and Manufacturer's Declaration: Electromagnetic Emission

Emission Test	Compliance	Electromagnetic Environment Guidance
Radiated EMISSIONS	CISPR 11:2015 +A1:2016+A2:2019 Group 1/Class A	The CDI OneView System does not generate any intentional RF. Therefore its RF emissions are very low and unlikely to cause interference in nearby electronic equipment.
Conducted EMISSIONS	CISPR 11:2015 +A1:2016+A2:2019 Group 1/Class A	The CDI OneView System is suitable for use in all establishments other than domestic and those directly connected to public low-voltage power supply networks that supply buildings used for domestic purposes.
Harmonic current EMISSIONS	IEC 61000-3-2 Class A	
Voltage changes + fluctuations and flicker EMISSIONS	IEC 61000-3-3	

Guidance and Manufacturer's Declaration: Electromagnetic Immunity

Immunity Test	IEC 60601-1-2 Test Level	Compliance Level	Electromagnetic Environment Guidance
Electrostatic discharge (ESD) IEC 61000-4-2	± 8 kV contact ± 15 kV air	± 8 kV contact ± 15 kV air	Floor should be wood, concrete or ceramic tile. If floors are covered with synthetic material, the relative humidity should be at least 30%.
Electrical fast transient/burst IEC 61000-4-4	± 2 kV (100 kHz repetition frequency) AC Mains	± 2 kV (100 kHz repetition frequency) AC Mains	Mains quality should be that of a typical commercial or hospital environment. Always use a hospital-grade power cord with the following specifications: Length: 3m Ampacity: 10A Termination: IEC 60320-C13

System Specifications

Guidance and Manufacturer's Declaration: Electromagnetic Immunity			
Immunity Test	IEC 60601-1-2 Test Level	Compliance Level	Electromagnetic Environment Guidance
Surge IEC 61000-4-5	± 1 kV line-line AC Mains ± 2 kV line-earth AC Mains	± 1 kV line-line AC Mains ± 2 kV line-earth AC Mains	Mains power quality should be that of a typical commercial or hospital environment. A temporary loss of function or degradation or performance that ceases after the surge event ends could occur.
RATED Power frequency magnetic fields IEC 61000-4-8	30 A/m 50Hz or 60Hz	30 A/m 50Hz or 60Hz	Power frequency magnetic fields should be at levels characteristic of a typical location in a typical commercial or hospital environment.
Voltage dips IEC 61000-4-11	0% U_T (100% dip U_T) 0.5 cycles (at 0°, 45°, 90°, 135°, 180°, 225°, 270° and 315°) 0% U_T (100% dip U_T) 1.0 cycle (at 0°) 70% U_T (30% dip U_T) 25/30 cycles (at 0° single phase)	0% U_T (100% dip U_T) 0.5 cycles (at 0°, 45°, 90°, 135°, 180°, 225°, 270° and 315°) 0% U_T (100% dip U_T) 2.0 cycle (at 0°) 70% U_T (30% dip U_T) 25/30 cycles (at 0° single phase)	Mains power quality should be that of a typical commercial or hospital environment. If the user of the CDI OneView System requires continued operation during power mains interruptions, it is recommended that the CDI OneView System be powered from an uninterruptible power supply or a battery.
Voltage interruptions IEC 61000-4-11	0% U_T (100% dip U_T) 250/300 cycles	0% U_T (100% dip U_T) 250/300 cycles	Note: U_T is the AC mains voltage prior to application of the test level.
RF wireless proximity fields IEC 61000-4-3	Tested as specified on page B-13 using test methods from IEC 61000-4-3	Refer to table on page B-13 .	Refer to page B-13 , "Recommended RF Separation Distance."
Proximity magnetic Fields IEC 61000-4-39	134.2 kHz Pulse modulation: 2.1 kHz 65 A/m 13.56 MHz Pulse modulation: 50 kHz 7.5 A/m	134.2 kHz Pulse modulation: 2.1kHz 65 A/m 13.56 MHz Pulse modulation: 50 kHz 7.5 A/m	CDI OneView BPM(s), H/S(s) and Flow Sensor(s) should not be positioned within six inches of a device using a magnetic field (e.g. an RFID reader).

System Specifications

Guidance and Manufacturer's Declaration: Electromagnetic Immunity			
Immunity Test	IEC 60601-1-2 Test Level	Compliance Level	Electromagnetic Environment Guidance
Conducted RF IE 61000-4-6	3 V _{rms} 150kHz to 80MHz Outside ISM bands	3 V _{rms} 150kHz to 80MHz Outside ISM bands	<p>Portable and mobile RF communications equipment should be used no closer to any part of the CDI OneView System, including cables, than the recommended separation distance calculated from the equation applicable to the frequency of the transmitter.</p> <p>Recommended separation distance</p> $d = 1.2 \sqrt{P}$ <p>150 kHz to 80 MHz</p> <p>where P is the maximum output power rating of the transmitter in watts (W) according to the transmitter manufacturer and d is the recommended separation distance in meters (m).</p> <p>Field strengths from fixed RF transmitters, as determined by an electromagnetic site survey ^a, should be less than the compliance level in each frequency range ^b.</p> <p>Interference may occur in the vicinity of equipment marked with the following symbol:</p> 
	6 V _{rms} ISM bands between 150kHz and 80MHz	6 V _{rms} ISM bands between 150kHz and 80MHz	
	80% AM at 1 kHz	80% AM at 1 kHz	

System Specifications

Guidance and Manufacturer's Declaration: Electromagnetic Immunity			
Immunity Test	IEC 60601-1-2 Test Level	Compliance Level	Electromagnetic Environment Guidance
Radiated RF IEC 61000-4-3	3 V _{rms} 80MHz to 2.7GHz	3 V _{rms} 80MHz to 2.7GHz	<p>Portable and mobile RF communications equipment should be used no closer to any part of the CDI OneView System, including cables, than the recommended separation distance calculated from the equation applicable to the frequency of the transmitter.</p> <p>Recommended separation distance $d = 1.2 \sqrt{P}$ at 80MHz to 800MHz $d = 2.3 \sqrt{P}$ at 800MHz to 2.7GHz</p> <p>where P is the maximum output power rating of the transmitter in watts (W) according to the transmitter manufacturer and d is the recommended separation distance in meters (m).</p> <p>Field strengths from fixed RF transmitters, as determined by an electromagnetic site survey ^a, should be less than the compliance level in each frequency range ^b.</p> <p>Interference may occur in the vicinity of equipment marked with the following symbol:</p> 

Note: At 80 MHz and 800 MHz, the higher frequency range applies

Note: These guidelines may not apply in all situations. Electromagnetic propagation is affected by absorption and reflection from structures, objects and people

^a Field strengths from fixed transmitters, such as base stations for radio (cellular/cordless) telephones and land mobile radios, amateur radio, AM and FM radio broadcast and TV broadcast cannot be predicted theoretically with accuracy. To assess the electromagnetic environment due to fixed RF transmitters, an electromagnetic site survey should be considered. If the measured field strength in the location in which the CDI OneView System is used exceeds the applicable RF compliance level above, the CDI OneView System should be observed to verify normal operation. If abnormal performance is observed, additional measures may be necessary, such as reorienting or relocating the CDI OneView System.

^b Over the frequency range 150 kHz to 80 MHz, field strengths should be less than 3 V/m.

System Specifications

Test Specifications for Enclosure Port Immunity to RF Wireless Communication Equipment				
Test Frequency (MHz)	Band ^{a)} (MHz)	Service ^{a)}	Modulation	IMMUNITY TEST LEVEL (V/m)
385	380 to 390	TETRA 400	Pulse modulation 18 Hz	27
450	430 to 470	GMRS 460, FRS 460	FM ± 5 kHz deviation 1 kHz sine	28
710 745 780	704 to 787	LTE Band 13, 17	Pulse modulation 217 Hz	9
810 870 930	800 to 960	GSM 800/900, TETRA 800, iDEN 820, CDMA 850, LTE Band 5	Pulse modulation 18 Hz	28
1,720 1,845 1,970	1,770 to 1,990	GSM 1800; CDMA 1900; GSM 1900; DECT; LTE Band 1, 3, 4, 25; UMTS	Pulse modulation 217 Hz	28
2,450	2,400 to 2,570	Bluetooth, WLAN, 802.11 b/g/n, RFID 2450, LTE Band 7	Pulse modulation 217 Hz	28
5,240 5,500 5,785	5,100 to 5,800	WLAN 802.11 a/n	Pulse modulation 217 Hz	9

Recommended RF Separation Distance

The CDI OneView System is intended for use in an electromagnetic environment in which radiated RF disturbances are controlled. The user can prevent electromagnetic interference by maintaining a **minimum distance of 30 cm (12 inches)** between portable and mobile RF communications equipment and any part of the CDI OneView System.

System Specifications

Additional Warnings and Precautions

Essential performance of the CDI OneView System is primarily to display monitored parameters within error tolerances and associated visual physiological alarms based on user-defined limits. Verify the accuracy of displayed values with another source (such as a laboratory or point-of-care blood gas analyzer) before initiating treatment if performance is lost or degraded due to EM disturbances.

There are no precautions specific to the CDI OneView System to be taken when a cardiac defibrillator is used on a patient. The typical recovery time from these events is less than 30 seconds.

There are no precautions specific to the CDI OneView System to be taken when operating in presence of high-frequency electrosurgical equipment or electrocautery instrument. The typical recovery time from these events is less than ten seconds.



Warning

- ✦ **Electromagnetic emission from the CDI OneView System may interfere with critical devices in its vicinity.**
- ✦ **Following standard practices for electronic devices, monitor this equipment closely when it is exposed to intense electrical noise or fluctuating line voltage. Strong electromagnetic fields radiated from equipment elsewhere in the operating room or fluctuations in AC line voltage may compromise performance or damage the equipment.**
- ✦ **Use of accessories, transducers or cables other than those specified or provided by the manufacturer of this equipment could result in increased electromagnetic emissions or decreased electromagnetic immunity of this equipment and result in improper operation.**
- ✦ **It is not recommended to use this system adjacent to or stacked with other equipment. If adjacent or stacked use is necessary, observe the system closely to verify normal operation in the configuration in which it will be used.**
- ✦ **Protection of the device against the effects of a cardiac defibrillator discharge is dependent upon the use of appropriate cables.**
- ✦ **Portable and mobile radio frequency (RF) communication equipment can affect this system. RF communications equipment include, but are not limited to, peripherals such as antenna cables, external antennas, cell phones, pagers, walkie-talkies and Bluetooth devices. Portable RF communications equipment should be used no closer than 30 cm (12 inches) to any part of the CDI OneView System, including cables specified for use by the manufacturer. Otherwise degradation of the performance of this equipment could result.**

System Specifications



Caution

- The ground equalization stud is used for external grounding of the device. In some countries, regulations require potential compensation. In this case, connect the cable from the potential compensation network to the ground equalization stud. The purpose of additional potential equalization is to equalize potentials between different metal parts that can be touched simultaneously or to reduce differences of potential which can occur during operation between the bodies of medical electrical devices and conductive parts of other objects. The ground equalization stud on the Core is a 6 mm diameter pin conforming to DIN 42801-part 1 Potential Equalization Leads - Connecting Pins. Use a connecting lead with a 6 mm socket conforming to DIN 42801-part 2 Potential Equalization Leads - Connecting Sockets.

Security

The CDI OneView System incorporates several features to ensure the security of the system. These features include inherent design elements as well as user settings and functions.

General Recommendations

The CDI OneView System has been designed to utilize a proprietary communication system to ensure only authorized CDI devices are used. As part of this implementation, the system utilizes notifications to the user of invalid values (shown as dashes "---") and error codes for improper communication as well as hardware issues. Action should be taken in accordance with the Troubleshooting section in response to these events.

A USB drive can be utilized for transferring data to and from the system. In accordance with your local policies, ensure the USB drive is properly secure. To protect the system from threats originating from the USB drive, the CDI OneView Display restricts the importing of case profiles to ADMIN ONLY mode. Additionally, CDI software upgrades are restricted to Terumo Cardiovascular Service personnel using Terumo Cardiovascular authenticated USB drives.

Barcode scanning can be used for entering user passwords during login or for entering K+ Code during BPM calibration. The following features are incorporated for barcode scanning security:

- The CDI Display will only accept barcodes of the specific predefined format for K+ Code entry. If an incorrect format is used, the system will display an invalid barcode error.
- If scanning is not completed within 20 seconds, the system will display a barcode read error.

User Accounts

The CDI OneView Display includes User Management features for Administrator users to create new users, assign password for user accounts, assign users a permission level of admin or normal user, and configure Security settings.

Security settings should be carefully considered in accordance with the security needs of the institution. Security settings include:

- Passwords Complexity: Complexity requirements for passwords can be set to High, Medium, or Low.

System Specifications

User Accounts (Continued)

- Login Requirements: User Access Control can be enabled to require all users to login with an account.
Note: After 10 successive incorrect password attempts, the user account will be locked for 30 minutes.
- Admin Inactivity Timeout: The Display can be configured to automatically logout Admin users, mitigating threats that may arise from unattended system with admin user logged in. The period of inactivity before the system logs the Admin user out can be configured between 5 to 90 minutes.

Further details on user management and configuring Security settings are available in Chapter 2, "Administrator Setup".

Device Security, Event and Error Logs

The CDI OneView System records and maintains activity logs at various levels across the CDI OneView components that may help with accountability and forensic purposes in the event of security concerns. Device Logs includes below but not limited to:

- CDI OneView Display maintains security logs that contains user account access information. The security logs can be saved as text files to the USB drive by administrator users.
- CDI OneView Core logs the information on CDI devices connection status changes, battery technical alarms and error logs.
- CDI OneView BPM Probe, H/S Probe and Flow maintains device configuration change logs.

All CDI OneView devices maintain logs pertinent to self-test failures, memory integrity checks and other service and maintenance purpose extended logs. These logs are accessible by Terumo Cardiovascular Technical Support.

Ongoing Security Information

In the event that new information regarding the security of the CDI OneView becomes available, Terumo Cardiovascular will notify users of such information or required actions. Such information includes security patches, identification of vulnerabilities, or security lifecycle information.

System Specifications

Physical Specifications

Component	Part #	Dimensions	Weight
Core	CDI750	22.2 cm x 27.2 cm x 8.3 cm	3 kg
Display + Backplate	CDI751	30 cm x 20.5 cm x 9.5 cm	2.4 kg
Calibrator	CDI740	23 cm x 21 cm x 18 cm	3.3 kg
Brackets	CDI780	21 cm x 15.5 cm x 12 cm	1.6 kg
	CDI781	47 cm x 28 cm x 9 cm	1.7 kg
	CDI782	32.4 cm x 18.6 cm x 8.2 cm	1 kg
	CDI783	19.2 cm x 9 cm x 5.8 cm	1 kg

Safe Working Loads

Brackets	Part #	Weight
Core	CDI780	10 kg
Display	CDI781	7 kg
BPM	CDI782	3.2 kg
Calibrator	CDI783	10 kg

Maximum Viewing Angles (As Measured from Normal)

Horizontal	±80 degrees
Vertical	+65, -80 degrees

Note: All dimensions are approximate and may vary slightly from product to product.

Priming Volumes

Module	Volume
Model CDI510H Shunt Sensor	1.2 mL
1/4" CDI H/S Cuvettes	4 mL
3/8" CDI H/S Cuvettes	9 mL
1/2" CDI H/S Cuvettes	16 mL

System Specifications

Unpacking and Inspection

The CDI OneView System has been packaged to prevent shipping damage. The cartons contain a Display (with a Display cable), Core (with a power cable) and Calibrator. The Display Bracket, Core Bracket, Calibrator Bracket, BPM Bracket, Calibration Gas Bottles, BPM Probes, H/S Probes, Calibrator Cable, External Data Modules, Flow Interface Module, and Flow Sensor are packaged separately. Be sure to keep all cartons and fillers.

If any items are missing, or if there is visible damage to any of the contents, notify the Customer Administration Department at Terumo Cardiovascular (800) 521-2818 promptly. They will provide instructions and make arrangements to resolve the problem.

Calculations

The following calculations are used to display each value. The calculated output depends on the availability and accuracy of the measured inputs.

O₂ Consumption (VO₂) mL/min =

$$10 \times \dot{Q} \times [(SaO_2 - SvO_2) \times (1.36 \times Hgb) + (PaO_2 - PvO_2) \times 0.0031]$$

Note: 1.36 is the constant used for mL O₂ per gram of hemoglobin. SO₂ values are expressed in fractional form (i.e., 100% = 1.0). \dot{Q} is expressed in L/min.

$$\text{Indexed VO}_2 \text{ (VO}_2\text{ i) mL/min/m}^2 = \text{VO}_2 / \text{BSA}$$

Note: BSA is patient's body surface area - expressed in m².

O₂ Delivery (DO₂) mL/min =

$$10 \times [(1.36 \times Hgb \times SaO_2) + (0.0031 \times PaO_2)] \times \dot{Q}$$

Note: 1.36 is the constant used for mL O₂ per gram of hemoglobin. SaO₂ values are expressed in fractional form (i.e., 100% = 1.0). \dot{Q} is expressed in L/min. 0.0031 is the constant used for partial pressure of oxygen in arterial blood. Partial pressure of oxygen (PaO₂) is expressed in mmHg.

$$\text{Indexed DO}_2 \text{ (DO}_2\text{ i) mL/min/m}^2 = \text{DO}_2 / \text{BSA}$$

Note: BSA is patient's body surface area - expressed in m².

$$\text{Oxygen Extraction (O}_2\text{ER) \%} = (\text{VO}_2 / \text{DO}_2) \times 100$$

$$\text{Cardiac Index Calculation (CI) L/min/m}^2 = \dot{Q} / \text{BSA}$$

Communication with Other Devices

The CDI OneView System has Modules that can connect to external devices to import or export patient parameter values over the course of an operation.

When using a CDI OneView Module with the Terumo™ Advanced Perfusion System 1 along with a CDI module, blood parameter values can also be displayed on the Central Control Monitor.

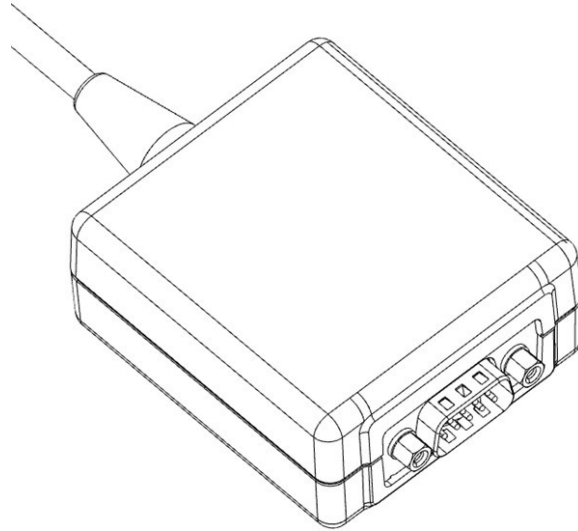

Warning

- ✦ **Computer equipment in the operating room environment may interfere with the operation of existing monitoring or therapeutic devices and may be susceptible to interference from such devices. To ensure that such interference will not occur, care must be taken in the selection of computer equipment or printers to be interfaced with the CDI OneView System and in the manner in which this interface is accomplished.**
- ✦ **Equipment connected to the Module's port should be certified according to IEC 60601-1 for medical equipment. All configurations should be checked for combined system leakage current within IEC 60601-1 leakage current specifications.**



Caution

- *Connecting unintended devices to the system could result in unidentified risks to patients and/or users.*
- *If unintended devices are connected to the system, the institution should identify, evaluate and control any new risks that may arise.*

Communication with Other Devices

Connecting an External Device to the Port

This section explains how to connect an external serial device to the CDI OneView and how to set the communication parameters.

1. **Use a 9-pin, D-type, RS-232 straight through cable to attach the CDI OneView Module to the external device.**

The cable must have a female connector to attach to the Module. The length and type of cable that attaches to the external device depends on the needs of that device. Check to make sure the connections are secure.

2. **Configure the device to communicate with the CDI OneView System.**

Follow the instructions in the device's manual to set the appropriate baud rate and other communication parameters. For DMS Output, use the following serial port settings: 38400 baud, 8 bits, no parity, 1 stop bit.

The serial port settings for Pump and Oximeter Devices are provided in the tables on pages C-5 and C-6.

3. **If you are connecting a DMS device, toggle on the Export to DMS option in the Data Options tab during Profile Configuration.**

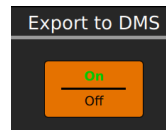

Note: The values sent to the external device at the specified interval are not averaged blood parameter values. They are the values displayed on the screen at the moment the data is sent.



Caution

- *Subsequent changes to a connection between the system and an external device could introduce unidentified risks requiring additional analysis. Such changes include altering communication or interface configuration, connecting additional devices, disconnecting interface configurations, and updating/upgrading external equipment communicating with the system.*

Communication with Other Devices

Data Output Port Pin Assignments

The CDI OneView Module output port is a male 9-pin D-Sub connector. This data output port is set up as a DCE (Data Communications Equipment) device at the factory. Hardware handshaking is not supported.

The CDI OneView Core has two levels of protection to isolate the patient from shocks caused by AC line faults occurring in devices attached to the serial interface.

The CDI OneView's Module serial interface follows the RS-232 standard as defined in the following table:

Pin Number	CDI OneView RS-232 Connection (DCE)	
2	Receive Data	Transmit Data
3	Transmit Data	Receive Data
5	Ground	Ground

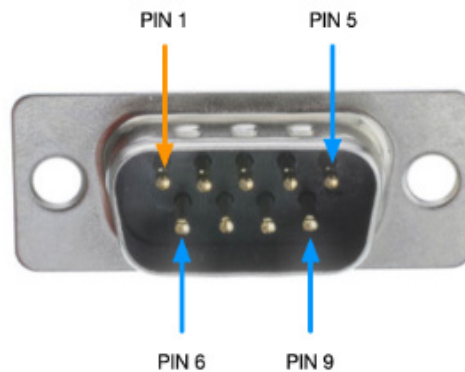

Communication to a hospital EMR may require a middleware program such as Capsule or Capture. Cables to connect CDI to the middleware or EMR system should be sourced commercially or through the hospital's Information Technology department.

In accordance with IEC 60601-1: Modules can only be connected to devices compliant with IEC 60601-1, IEC 60950-1 or IEC 62368-1. When the CDI OneView System is being used on a patient, do not simultaneously touch the patient and parts of nonmedical equipment. If in doubt consult Terumo Cardiovascular Technical Support or your local representative.

Communication with Other Devices

Receiving Data from Pumps and Oximeters

See [Chapter 2, "Module Connections"](#) for connecting pumps and oximeters through Modules and see [Chapter 3, "Sensor Connections"](#) for case profile setup.



Caution

- Each type of device will require a separate interface cable specially configured for that device and the CDI OneView System. Please see the following section on interfacing tips, or contact your Terumo Cardiovascular Technical Service Representative for assistance.

If a pump and/or oximeter is selected in the **Sensor Connections Tab**, the CDI OneView System will begin looking for pump flow data and/or oximetry from the Module(s) upon entering Measurement Mode. If no data is received within a certain time period, the pop-up *Check HLM Interface Module connections* or *Check RSO₂ Interface Module connections* will appear. The system will reattempt reception of data at regular intervals until the case profile is changed.

Interfacing Tips

Any interface cable used is specific to each device and should be ordered from Terumo Cardiovascular Customer Administration. These cables will only connect to the HLM or RSO₂ Interface Modules.

Note: Please consult the operator's manual of the specific device being used for instructions on how to properly set up data export through its serial interface.

Supported Pump Systems

The CDI OneView System supports the following pumping system interfaces:

- Terumo™ Advanced Perfusion System 1
- Terumo™ NEO System
- LivaNova S5/C5®
- Medtronic Bio-Console® 560

Supported Oximeter Systems

The CDI OneView System supports the following oximeters:

- Nonin SenSmart® X-100
- Edwards ForeSight Elite®
- Medtronic INVOS™ 5100c

Communication with Other Devices

Pump System	Special Instructions
<p>Terumo™ Advanced Perfusion System 1</p>	<p>Interfacing with the Terumo™ Advanced Perfusion System 1 can only be done with the CDI interface module (part number 803479). The System 1 Perfusion screen must be configured to include the CDI module. See the System 1 Operator’s Manual for instructions on adding the CDI module to a perfusion screen configuration. The physical connection between the CDI module of the System 1 to the CDI OneView System is the same process as the CDI System 500 or 550.</p> <p>Make sure the correct interface cable is used (part number 804981), and that it is connected in the proper orientation (see labels on cable to determine correct orientation).</p> <p>The CDI uses the following serial port settings to communicate with System 1: 19200 baud, 8 bits, no parity, 1 stop bit.</p> <p>To set up the CDI OneView System, select the System 1 HLM in the Sensor Connections tab.</p>
<p>Terumo™ NEO System</p>	<p>No special instruction available. The customized interface cable is an accessory of the Terumo NEO System. Follow the instruction of the Terumo NEO System to make the connection between the CDI OneView System and Terumo NEO System.</p> <p>The CDI uses the following serial port settings to communicate with the NEO: 19200 baud, 8 bits, no parity, 1 stop bit.</p>
<p>LivaNova S5/ C5®</p>	<p>Interfacing with the LivaNova S5/C5 pumping systems requires use of the LivaNova interface DDD module. Use the serial interface cable supplied by LivaNova.</p> <p>The CDI uses the following serial port settings to communicate with the S5: 9600 baud, 7 bits, no parity, 2 stop bits.</p>
<p>Medtronic Bio-Console® 560</p>	<p>The Bio-Console interface protocol must be set to:</p> <ul style="list-style-type: none"> • 9600 baud • 8 bits • no parity 1 stop bit <p>This is the default setting from the factory. If you believe the setting has been changed, contact Medtronic Technical Service to make adjustments.</p> <p>Use the serial interface cable supplied by Medtronic.</p> <p>Note: On the Medtronic connector, pin 2 is assumed to be RX (IN) and pin 3 is TX (OUT). Hardware handshaking is not supported.</p>

Communication with Other Devices

Oximeter	Special Instructions
<p>Nonin SenSmart® X-100</p>	<p>The SenSmart must be configured for the <i>Nonin 5</i> output data format. Refer to the SenSmart User manual or contact Nonin Technical Service for assistance.</p> <p>A female/female straight through cable is required to interface the SenSmart to the Module.</p> <p>The CDI uses the following serial port settings to communicate with the SenSmart: 57600 baud, no parity, 8 bits, one stop bit.</p>
<p>Edwards ForeSight Elite®</p>	<p>The Elite must be configured for the CSV output data format. Both 2-channel and 4-channel modes are supported, and both Ports A and B may be used. The Baud must be set to 115200. Refer to the Elite user manual or contact Edwards Technical Service for assistance.</p> <p>A female/female straight through cable is required to interface the Elite to the Module.</p> <p>The CDI uses the following serial port settings to communicate with the Elite: 115200 baud, no parity, 8 bits, one stop bit.</p>
<p>Medtronic INVOS™ 5100c</p>	<p>The INVOS must be configured for the <i>Output Format 1</i> output data format. Refer to the INVOS user manual or contact Medtronic Technical Service for assistance.</p> <p>A female/female straight through cable is required to interface the INVOS to the Module.</p> <p>The CDI uses the following serial port settings to communicate with the INVOS: 9600 baud, no parity, 8 bits, one stop bit.</p>

Communication with Other Devices

CDI Pump Interface Protocol

The CDI Pump Interface is a two-way communications protocol designed for future pumping systems, including the Terumo™ Advanced Perfusion System 1. It provides a flexible format to allow the CDI OneView System to get flow data as desired from the pump and for the pumping system to request data as desired from the system.

Hardware protocol

The CDI OneView System hardware supports RS-232 signals on the Module, which is used for communication with pumping systems. Since only one type of communication is necessary, the CDI Pump Interface Protocol supports RS-232 only.

RS-232 Parameters

The CDI OneView Pump Interface packet communication will have RS-232 parameters adjusted automatically based on the pump selected.











Software Support

The CDI OneView System supports both sending and receiving messages to and from a pumping system or other device.













- The communication packet infrastructure has start and stop characters in binary, with the rest of the packet in ASCII. Binary data transfers are not supported.
- The communication packet contains an 8-bit CRC for error detection. Upon failing the CRC, a NAK packet will be returned. The behavior for acting on a NAK is to retransmit.
- The packet contains an 8-bit sequence counter that will define the order in which packets are sent and received. The sequence of outgoing packets is independent of the sequence of incoming packets.
- The packet sent to the CDI OneView System, when successfully received, outputs either an acknowledge packet or an attention packet depending on the command. If there is a problem with the packet structure, command combination, packet length, CRC or parameter value, the CDI OneView System will produce a no-acknowledge (NAK) packet. If no response is received from the CDI OneView System after a packet is sent, it can be assumed that a communication error has occurred and a retransmit is required.

Symbols Glossary







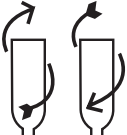







The following symbols may appear in the labeling, marking or display of the CDI OneView. These symbols are in accordance with the internationally harmonized standards.

Symbol	Title	Description	Source
	Operator's Manual; operating instructions	To indicate that the operating instructions should be considered when operating the device or control close to where the symbol is placed.	ISO 7000-1641
	Refer to instruction manual/booklet	To signify that the instruction manual/booklet must be read.	ISO 7010-M002
	Warning	Indicates the need for the user to consult the instructions for use for important warnings that cannot be presented on the medical device itself.	ISO 7010-W001
	Caution	Indicates the need for the user to consult the instructions for use for important precautions that cannot be presented on the medical device itself.	ISO 15223-1-5.4.4
	Protective earth ground	Protective earth ground.	IEC 60417-5019
	Defibrillation - Proof Type CF Applied Part	Patient applied part.	IEC 60417-5336
	Alternating current	To indicate on the rating plate that the equipment is suitable for alternating current only; to identify relevant terminals.	IEC 60417-5032
	Direct current	Direct current.	IEC 60417-5031
	Equipotentiality	Equipotentiality.	IEC 60417-5021
	Fuse	Fuse.	IEC 60417-5016
IP32	Protected against direct sprays of water up to 15 degrees from vertical Protected from tools and wires greater than 2.5 millimeters	Drip proof in accordance with IEC 60529.	IEC 60529
IPX2	Protected against vertically falling water drops when enclosure tilted up to 15°	Drip proof in accordance with IEC 60529.	IEC 60529
IPX4	Resistant against water from any direction	Water Resistant in accordance with IEC 60529.	IEC 60529
	The PSE mark will be on the fuse	Design compliance to Law No. 234 of 1961.	Denan Guide for compliance with Japan Regulations















Symbols Glossary

Symbol	Title	Description	Source
Hz	Hertz	Hertz.	The International System of Units (SI)
A	Ampere	Ampere.	The International System of Units (SI)
V	Volt	Volt.	The International System of Units (SI)
	Serial number	Indicates the manufacturer's serial number so that a specific medical device can be identified.	ISO 15223-1-5.1.7
	Manufacturer	Indicates the medical device manufacturer, as defined in EU Directives 90/385/EEC, 93/42/EEC and 98/79/EC.	ISO 15223-1-5.1.1
	Fragile, handle with care	Indicates a medical device that can be broken or damaged if not handled carefully.	ISO 15223-1-5.3.1
	Keep dry	Indicates a medical device that needs to be protected from moisture.	ISO 15223-1-5.3.4
	This way up	This way up.	ISO 7000-0623
	Date of manufacture	Indicates the date when the medical device was manufactured.	ISO 15223-1-5.1.3
	Temperature limitation	Indicates the temperature limits to which the medical device can be safely exposed.	ISO 15223-1-5.3.7
	Humidity limitation	Indicates the range of humidity to which the medical device can be safely exposed.	ISO 15223-1-5.3.8
	Battery recycling (European)	Battery recycling (European).	WEEE 2012/19/EU
	Battery recycling (USA)	Battery recycling (USA).	ISO 7000-1135
	Gas 1	Gas 1.	Terumo Cardiovascular
	Gas 2	Gas 2.	Terumo Cardiovascular
	Number of contents in carton	Identifies the number of contents.	Terumo Cardiovascular
	Twist to remove/tighten gas bottles	Twist to remove/tighten gas bottles.	Terumo Cardiovascular

















Symbols Glossary

Symbol	Title	Description	Source
	Non-ionizing radiation	Non-ionizing radiation.	IEC 60417-5140
	Catalogue Number	Indicates the manufacturer's catalogue number so that the medical device can be identified.	ISO 15223-1-5.1.6
	Authorized representative in the European Community	Indicates the Authorized representative in the European Community.	ISO 15223-1-5.1.2
	ETL Mark	Listed by Intertek with respect to electrical shock, fire, and mechanical hazards in accordance with IEC 60601-1:2005/2012 and CAN/CSA C22.2 No. 60601-1.	Intertek
	WEEE	This standard applies to Electronic equipment in accordance with article 11(12) of Directive 2002/96/EC.	Directive 2002/96/EC
Rx Only	Prescription only	Caution: Federal (U.S.A.) law restricts this device to sale, distribution and use by or on the order of a physician.	21 CFR 801.109
	Batch code	Indicates the manufacturer's batch code so that the batch or lot can be identified.	ISO 15223-1-5.1.5
	Importer	Indicates the entity importing the medical device into the locale.	ISO 15223-1:2021 (5.1.8)
	Medical device	Indicates the item is a medical device.	ISO 15223-1:2021 (5.7.7)
	Use-by date	Indicates the date after which the medical device is not to be used.	ISO 15223-1-5.1.4
	Do Not Resterilize	To indicate that the device should not be re-sterilized after it once has been sterilized.	ISO 7000-2608
	Do Not Use if Package is Damaged	To indicate that the device must not be used if the package holding the device is damaged.	ISO 7000-2606
	Fluid Path	On medical devices: to indicate the flow path for fluids.	ISO 7000-2722
	Sterilized using irradiation	To indicate that the device is provided sterile and has been sterilized using irradiation.	ISO 7000-2502
	Sterilized using ethylene oxide	To indicate that the device is provided sterile and has been sterilized using ethylene oxide.	ISO 7000-2501
	Non-Pyrogenic	On medical devices: to indicate that the product is non-pyrogenic.	ISO 7000-2724
Hg	Mercury; Chemical Symbol	Mercury is a chemical element.	2006/66/EC













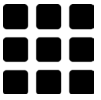
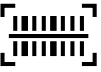

Symbols Glossary

Symbol	Title	Description	Source
Cd	Cadmium; Chemical Symbol	Cadmium is a chemical element.	2006/66/EC
Pb	Lead; Chemical Symbol	Lead is a chemical element.	2006/66/EC
3	Aerosol Dispenser	To indicate an aerosol dispenser.	EU Dir 75/324/EEC
	Gas Under Pressure	Contains gas under pressure; may explode if heated.	EU Dir 75/324/EEC
	Keep Away from Sunlight	Keep the product away from sunlight.	ISO 15223-1:2021
	Functional Earth Terminal	To indicate a ground terminal.	IEC 60417: 2002
	China Restriction of Hazardous Substances (RoHS)	Environment Friendly Use Period (EFUP) of ten years.	SJ/T 11364-2014
	New	Create new item.	Terumo Cardiovascular
	Deselect	Deselect item.	Terumo Cardiovascular
	Select all	Select all items.	Terumo Cardiovascular
	Copy	Copy.	Terumo Cardiovascular
	Delete	Delete.	Terumo Cardiovascular
	Rename	Rename item.	Terumo Cardiovascular
	Export	Export selected items.	Terumo Cardiovascular
	Import	Import selected items.	Terumo Cardiovascular
	AC power – Battery full	System is plugged in, and battery is fully charged.	Terumo Cardiovascular
	AC power – Battery @ 25 minutes	System is plugged in, and battery has 25 minutes of backup power.	Terumo Cardiovascular















Symbols Glossary

Symbol	Title	Description	Source
	AC power – Battery @ 20 minutes	System is plugged in, and battery has 20 minutes of backup power.	Terumo Cardiovascular
	AC power – Battery @ 15 minutes	System is plugged in, and battery has 15 minutes of backup power.	Terumo Cardiovascular
	AC power – Battery @ 10 minutes	System is plugged in, and battery has 10 minutes of backup power.	Terumo Cardiovascular
	AC power – Battery @ 5 minutes	System is plugged in, and battery has 5 minutes of backup power.	Terumo Cardiovascular
	AC power – Battery no charge	System is plugged in, and battery has no charge.	Terumo Cardiovascular
	On battery – 25 minutes	System is on battery power with 25 minutes remaining.	Terumo Cardiovascular
	On battery – 20 minutes	System is on battery power with 20 minutes remaining.	Terumo Cardiovascular
	On battery – 15 minutes	System is on battery power with 15 minutes remaining.	Terumo Cardiovascular
	On battery – 10 minutes	System is on battery power with 10 minutes remaining.	Terumo Cardiovascular
	On battery – 5 minutes	System is on battery power with 5 minutes remaining.	Terumo Cardiovascular
	On battery – system shutdown	System is on battery power. Battery is nearly depleted, and system shutdown is imminent.	Terumo Cardiovascular
	Back	Go back.	Terumo Cardiovascular
	AC power	AC power plugged in.	Terumo Cardiovascular
	No AC power	AC power not plugged in.	Terumo Cardiovascular
	Right caret	Additional information available.	Terumo Cardiovascular
	Down caret	Additional information shown.	Terumo Cardiovascular
	Dark mode	Dark mode.	Terumo Cardiovascular







Symbols Glossary

Symbol	Title	Description	Source
	Light mode	Light mode.	Terumo Cardiovascular
	Admin/System settings	System settings.	Terumo Cardiovascular
	Data export	Access to case data and log export.	Terumo Cardiovascular
	Calibrate	Gas calibration.	Terumo Cardiovascular
	Configure	Case profile configuration.	Terumo Cardiovascular
	Measure	Measurement mode.	Terumo Cardiovascular
	Barcode	Activate barcode reader.	Terumo Cardiovascular
	Show	Show password.	Terumo Cardiovascular
	Hide	Hide password.	Terumo Cardiovascular
	Fail	Failure.	Terumo Cardiovascular
	Success	Success.	Terumo Cardiovascular
	Skip	Skip calibration.	Terumo Cardiovascular
	Pop-up check	Confirmation successful.	Terumo Cardiovascular
	Home	Home.	Terumo Cardiovascular
	Multi-graph	Multi-graph view.	Terumo Cardiovascular
	Alarm settings	Alarm settings.	Terumo Cardiovascular

Symbols Glossary

Symbol	Title	Description	Source
	Alarm pause	Alarm pause.	Terumo Cardiovascular
	Alarm mute	Alarm mute.	Terumo Cardiovascular
	Alarm on	Alarm on.	Terumo Cardiovascular
	Store/Recall	Store and recalibrate lab values.	Terumo Cardiovascular
	Add event	Add event.	Terumo Cardiovascular
	Event flag	Event flag on graph.	Terumo Cardiovascular
	Measurement Mode	Measurement Mode active.	Terumo Cardiovascular
	Pause Mode	Measurement Mode paused.	Terumo Cardiovascular
	Screenshot	Take screenshot of current Display view.	Terumo Cardiovascular
	Volume	Control volume.	Terumo Cardiovascular
	Left caret	Navigate left.	Terumo Cardiovascular
	Right caret	Navigate right.	Terumo Cardiovascular
	Up caret	Increase value.	Terumo Cardiovascular
	Down caret	Decrease value.	Terumo Cardiovascular
	Normal user	Normal user access.	Terumo Cardiovascular

Symbols Glossary

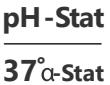
Symbol	Title	Description	Source
	Admin user	Admin user access.	Terumo Cardiovascular
	1x1 tile size	Parameter is 1x1 tile size.	Terumo Cardiovascular
	1x2 tile size	Parameter is 1x2 tile size.	Terumo Cardiovascular
	2x2 tile size	Parameter is 2x2 tile size.	Terumo Cardiovascular
	Handle	Item in list is ready to be moved up or down.	Terumo Cardiovascular
	Backspace	Backspace/Clear.	Terumo Cardiovascular
	Help	On-screen help/instructions.	Terumo Cardiovascular
	Temperature mode	Current temperature mode.	Terumo Cardiovascular

Standards

- 2006/66/EC:** Directive of the European Parliament and of the Council.
- BS EN 15986:** Symbol for use in the labeling of medical devices. Requirements for labeling of medical devices containing phthalates.
- IEC 60417:** Graphical symbols for use on equipment.
- IEC 60529:** Degrees of protection provided by enclosures (IP Code).
- ISO 7000:** Standard for graphical symbols for use on equipment — Registered symbols.
- ISO 15223-1:** Medical Devices — Symbols to be used with medical device labels, labeling and information to be supplied Part 1: General Requirements.
- ISO 20417:** Medical Devices — Information to be supplied by the manufacturer.
- UL248-14:** Standard for Safety Low-Voltage Fuses - Part 14: Supplemental Fuses.

Warranty and Service

Warranties

Terumo Cardiovascular warrants that its CDI OneView System will be free from defects in materials and manufacturing for one year from the date they are shipped. Terumo Cardiovascular warrants that its accessories will be free from defects in materials and manufacturing for 90 days from the date they are shipped.

Terumo Cardiovascular warrants that its disposables will be free from defects in materials and manufacturing until the stated expiration date.

Terumo Cardiovascular also warrants that the Display, Core, Calibrator and probes will be fit for use in accordance with CDI OneView System indications for use. Terumo Cardiovascular does not warrant that they are fit for any other use.

This warranty does not cover Display, Core, Calibrator and probes that are damaged through no fault of Terumo Cardiovascular. Only service representatives authorized by Terumo Cardiovascular may service the Display, Core, Calibrator and probes. This warranty does not cover damage due to unauthorized service.

Because the operation of the CDI OneView Display, Core, Calibrator and probes depends on factors which are out of Terumo Cardiovascular's control (such as the care of the products and the particular circumstances of the surgery), Terumo Cardiovascular does not warrant that its Display, Core, Calibrator and probes will be 100% effective in all circumstances.

Limitations of Remedies

Terumo Cardiovascular at its option will repair, replace or refund the purchase price of any component, disposable or accessory that is defective in material or manufacturing during the appropriate warranty periods.

The customer must notify Terumo Cardiovascular of the defect within 30 days of discovering any defect and no later than 30 days after the end of the appropriate warranty period. The customer must then return the component, disposable or accessory, freight prepaid, to Terumo Cardiovascular, CDI Products. The returned goods (RG) policy, as stated on the following page, must be followed.

THIS REMEDY IS YOUR EXCLUSIVE REMEDY. Terumo Cardiovascular will not be liable for any consequential or incidental damages, including lost profits.

Warranty and Service

Service

Except for routine cleaning, battery charging and fuse replacement, any servicing of the components of the CDI OneView System must be performed by Terumo Cardiovascular or an authorized service organization.

If you suspect instrument malfunction, please review the Troubleshooting section of this manual to determine the possible cause. Terumo Cardiovascular maintains a Technical Service Hotline to assist you in troubleshooting the system.

Should repair be necessary, a technical service or customer administration representative will authorize a replacement instrument. In order to expedite this process, please have the product serial or lot number and a detailed description of the abnormal behavior of the product available when calling. For the most efficient use of the troubleshooting process, the product should be close at hand for the execution of some simple tests during the telephone conversation.

Phone:	(800) 521-2818	Customer Administration
	(800) 441-3220	Technical Support

Returned Goods Policy

The customer must receive Terumo Cardiovascular's authorization to return goods by calling Terumo Cardiovascular's Customer Administration Department. Any device or component returned to Terumo Cardiovascular should be sent in its original packaging, or equivalent packaging material, in order to minimize possible damage during transit. Please be prepared to provide the product description, the quantity of product to be returned, the lot or serial numbers, and the reason for the return. Terumo Cardiovascular may give authorization at its discretion.



Warning

- ✦ **Gas bottles must be removed prior to returning a Calibrator. Improper shipment of gas bottles is an explosion hazard.**

Terumo Cardiovascular will not authorize the return of goods which are not in new and resalable condition, which have fewer than 90 days remaining prior to the expiration date, or which do not appear on Terumo Cardiovascular's most recently published price list. Terumo Cardiovascular may inspect returned goods. If Terumo Cardiovascular determines that the returned goods are unacceptable, Terumo Cardiovascular may refuse to issue any credit. Terumo Cardiovascular will notify the customer that it will not issue credit and will hold the returned goods for 30 days for the customer's inspection. After that time Terumo Cardiovascular will dispose of the returned goods.

Terumo Cardiovascular will identify which products it authorizes the customer to return and will give a returned goods (RG) number. The RG number must appear on the shipping container of all returned products. If the return is due to Terumo Cardiovascular's shipping error, Terumo Cardiovascular will give 100% credit against the invoice price (less discounts). Otherwise, Terumo Cardiovascular will grant a 90% credit against the original invoice price (less discounts, freight, taxes, etc.). Terumo Cardiovascular Sales Representatives are not authorized to accept returned goods from customers.

Software License

End User License Agreement: CDI OneView System Software

Important/read carefully: This License Agreement (“Agreement”) is a legal agreement between you and Terumo Cardiovascular for the computer software installed on the CDI OneView, which includes computer software and associated documentation (“SOFTWARE”). By using the SOFTWARE, you agree to be bound by the terms of this Agreement. The SOFTWARE is protected by copyright laws and treaties, as well as other intellectual property laws. The SOFTWARE is licensed, not sold, to you.

1. **GRANT OF LICENSE.** You are hereby granted a non-exclusive, non-transferable, non-assignable license to install and use one copy of the SOFTWARE on the CDI OneView. The SOFTWARE is intended specifically for use on the CDI OneView, and may not under any circumstances be utilized or operated on any other processor without the express written permission of Terumo Cardiovascular.
2. **LIMITATIONS.** You agree to not decompile, decrypt, disassemble, reverse engineer, or otherwise reduce the SOFTWARE to a human-perceivable form, even if such activity is expressly permitted by applicable law in the absence of an agreement. You may not rent or lease the SOFTWARE.
3. **UPGRADES.** If you receive an upgrade or other revision to the SOFTWARE you agree to immediately install the upgrade on the CDI OneView. The upgrade will be considered SOFTWARE for the purposes of this Agreement.
4. **COPYRIGHT.** All title and copyrights in and to the SOFTWARE (including but not limited to any source code, object code, images, and text incorporated into the SOFTWARE), the accompanying printed materials, and any copies of the SOFTWARE are owned by Terumo Cardiovascular. As the SOFTWARE is copyrighted, you must treat the SOFTWARE as you do any other copyrighted material except that you may make one copy of the SOFTWARE for backup purposes. You may not copy the printed materials accompanying the SOFTWARE.
5. **TERMINATION.** You may terminate this Agreement at any time without notice to Terumo Cardiovascular. This Agreement will terminate immediately without notice to you if you fail to strictly comply with the terms of this Agreement. This Agreement will also terminate should there be an unremedied breach of your obligations under any Bundle Purchase Agreement, Equipment Loan Agreement, or other agreement with Terumo Cardiovascular pertaining to the CDI OneView System. Upon any such termination, you will immediately cease utilizing the SOFTWARE and return the SOFTWARE to Terumo Cardiovascular. These termination provisions shall be in addition to any other remedies available to Terumo Cardiovascular at law or equity.
6. **LIMITED WARRANTY.** Terumo Cardiovascular warrants only that the SOFTWARE will, for a period of one year following shipment of the CDI OneView, function in accordance with the instructions furnished with the SOFTWARE. Should the SOFTWARE fail to properly function, Terumo Cardiovascular’s sole obligation will be to utilize reasonable commercial efforts to resolve the problem, or at the option of Terumo Cardiovascular, to replace the SOFTWARE. To obtain warranty service, contact Terumo Cardiovascular at the address listed in “Notices” below. TERUMO CARDIOVASCULAR DISCLAIMS ALL OTHER WARRANTIES, EXPRESS OR IMPLIED, INCLUDING WARRANTIES OF MERCHANTABILITY OR FITNESS FOR A PARTICULAR PURPOSE. TERUMO CARDIOVASCULAR DOES NOT WARRANT THAT THE SOFTWARE WILL BE ERROR-FREE, OR THAT THE SOFTWARE WILL BE FREE OF VIRUSES AND OTHER HARMFUL ELEMENTS.

Software License

7. **LIMITATION OF LIABILITY.** IN NO EVENT WILL TERUMO CARDIOVASCULAR BE LIABLE FOR INDIRECT, SPECIAL, INCIDENTAL OR CONSEQUENTIAL DAMAGES BASED UPON BREACH OF WARRANTY, BREACH OF CONTRACT, TORT, STRICT LIABILITY OR OTHER LEGAL THEORY ARISING OUT OF THE INSTALLATION OF, USE OF, OR INABILITY TO USE THE SOFTWARE, EVEN IF TERUMO CARDIOVASCULAR HAS BEEN ADVISED OF THE POSSIBILITY OF SUCH DAMAGES. TERUMO CARDIOVASCULAR'S LIMIT OF LIABILITY FOR DIRECT DAMAGES HEREUNDER, REGARDLESS OF LEGAL THEORY OR CAUSE OF ACTION, SHALL BE LIMITED TO THE LICENSE FEE PAID TO TERUMO CARDIOVASCULAR.
8. **EXPORT REGULATION.** The SOFTWARE is subject to export control laws and regulations of the United States and may be subject to export or import regulations and laws of other countries. The SOFTWARE shall not be downloaded by, exported or re-exported to, any country currently under an embargo of the United States Government, including but not limited to Cuba, Iran, Iraq, Libya, North Korea, Sudan, Syria, or to anyone on the U.S. Treasury Department's list of Specially Designated Nationals or the United States Department of Commerce's Table of Denial Orders.
9. **GOVERNMENT END USERS.** The SOFTWARE is considered "Commercial Items" as defined in 48 C.F.R.2.101, consisting of "Commercial Computer Software" and "Commercial Computer Software Documentation" as defined in 48 C.F.R.12.212 or 48 C.F.R.227.7202 as applicable. The SOFTWARE is being licensed to U.S. Government end users (a) only as Commercial Items and (b) with only those rights granted to all other end users pursuant to the Agreement.
10. **GOVERNING LAW.** This Agreement shall be governed by and construed in accordance with the laws of the United States and the State of Michigan, as applied to agreements entered into and to be performed entirely within Michigan by Michigan residents. If you acquire this Software outside of the United States, the laws of the United States and the State of Michigan shall apply to this Agreement.
11. **SEVERABILITY.** If for any reason a court of competent jurisdiction finds any provision of this Agreement, or portions thereof, to be unenforceable, that provision of the Agreement shall be enforced to the maximum extent permissible so as to affect the intent of the parties, and the remainder of this Agreement shall continue in full force and effect.
12. **COMPLETE AGREEMENT.** This Agreement constitutes the entire agreement between the parties with respect to the SOFTWARE. No amendment to or modification of this Agreement will be binding unless in writing and signed by a duly authorized representative of Terumo Cardiovascular.
13. **NOTICES.** Notices required to be sent to Terumo Cardiovascular under the terms of this Agreement should be sent to: Customer Service, Terumo Cardiovascular Systems Corporation, 6200 Jackson Rd., Ann Arbor, MI 48103, USA.

Glossary and Acronyms

Note: These definitions are specific to the Terumo Cardiovascular CDI OneView™ System.

Alpha-stat

Maintenance of a constant OH⁻/H⁺ ratio, accomplished by measuring blood gas values at 37°C and keeping a constant pH of 7.40 and pCO₂ of 40 mmHg.

Aseptic technique

Used when placing a sterile CDI H/S Cuvette or CDI Shunt Sensor into the extracorporeal circuit. Have a sterile team member place the sterile CDI component into the line or use a sterile blade to cut into a sterilized circuit.

Base excess (B.E.)

The sum of all the conjugate bases in one liter of whole blood.

Bicarbonate (HCO₃⁻)

The primary buffering system of the body. It minimizes changes in pH when either acids or bases are added to the blood.

Blood Parameter Module (BPM)

Arterial and/or venous cable modules are used to measure pH, pCO₂, pO₂, K⁺ and temperature.

Buffer solution

A solution in the sensor that stabilizes the microsensors during storage. It also reacts with the tonometered gases during calibration to establish predictable pH, pCO₂, pO₂ and K⁺ values. It cannot be replaced with other solutions.

Cardiac Index (CI)

Relates cardiac output per minute to body surface area, thus providing a metric of heart performance based on the size of the individual.

DMS

Data Management System.

Hematocrit (HCT)

The volume percentage of red blood cells in the blood.

Hemoglobin (Hgb)

The iron-containing protein complex in red blood cells that combines with oxygen and carbon dioxide.

H/S

Hematocrit/Saturation.

Glossary and Acronyms

In vivo recalibration

Recalibrating the CDI OneView System during on-line operation so that its measured values correlate more closely with those from the institution's blood parameter laboratory.

LEDs

Light Emitting Diodes.

Mean

A numerical average calculated as the sum of all values in the set divided by the number of values in the set.

Microsensors

Small dots of fluorescent chemicals on the sensor body that emit light in response to flashes of light from the LEDs correlating to the amount of substrate present.

Non-pyrogenic

Not fever-producing.

Nontoxic

Not poisonous or productive of poison.

Optical interface material

A transparent material found on the back of the CDI Model CDI510H Shunt Sensor that reduces the risk of measurement errors caused by moisture or air trapped between the microsensors and the fiber optics.

Oxygen consumption (VO_2)

The amount of oxygen consumed by the tissues, expressed in mL O_2 /minute.

Oxygen delivery (DO_2)

The amount of oxygen delivered to the patient during CPB, expressed in mL per minute.

Oxygen extraction ratio (O_2ER)

The ratio of oxygen consumption (VO_2) to oxygen delivery (DO_2).

Oxygen Saturation (SO_2)

The amount of oxygen bound to hemoglobin in the blood, expressed as a percentage of the maximal binding capacity.

Potential of Hydrogen (pH)

The unit for measuring the degree of acidity or alkalinity of a substance as related to its concentration of hydrogen ions.

Glossary and Acronyms

pH-stat

Maintenance of a constant pH at 7.40 and $p\text{CO}_2$ at 40 mmHg, over varying temperatures, accomplished by measuring blood gas values at actual patient temperature.

Partial Pressure of Carbon Dioxide ($p\text{CO}_2$)

The pressure exerted by carbon dioxide gas in the blood.

Partial Pressure of Oxygen ($p\text{O}_2$)

The pressure exerted by oxygen gas in the blood.

Potassium (K^+)

The major cation of intercellular fluid.

\dot{Q}

Blood value accurate up to mL/min obtained manually, via Flow Sensors connected through the Flow Interface Module or via supported pumps connected through the HLM Interface Module.

Standard deviation (precision)

A measure of how spread out the values in a data set are.

SRS

Standard reference sensor.

Thermistor

A silver cap located on the BPM that measures the temperature of the blood when connected to a sensor.

Tonometered

A measurement characteristic of the calibration gases used with the CDI OneView System. The gas concentrations used with the CDI OneView System meet guaranteed specifications to ensure every gas bottle provides consistent calibration.

Two-point tonometered gas calibration

A calibration procedure that uses the supplied gas bottles to deliver a precise mixture of CO_2 and O_2 gas in order to expose the sensors to well defined pH, $p\text{CO}_2$ and $p\text{O}_2$ values. The Core determines the intensities related to these specific points and draws a slope and intercept value from them.



TERUMO CARDIOVASCULAR SYSTEMS CORPORATION
6200 Jackson Road, Ann Arbor, MI 48103, USA

Date of Release
May 2024



EC REP TERUMO EUROPE N.V.

Interleuvenlaan 40, 3001 Leuven, Belgium

TERUMO AUSTRALIA PTY LTD

Macquarie Park NSW 2113 Australia

TERUMO CORPORATION

Tokyo 151-0072, Japan

Product of US
90002660 R/F